

SPECIFICATION

Device Name: IGBT _____

Series : High-Speed W _____

Type Name : FGW75N60WQ _____

Spec. No. : MS5F9141 _____

Date : Mar.-8-2017 _____

This material and the information herein is the property of Fuji Electric Co.,Ltd. They shall be neither reproduced, copied, lent, or disclosed in any way whatsoever for the use of any third party nor used for the manufacturing purposes without the express written consent of Fuji Electric Co.,Ltd.

REVISIONS		

	DATE	NAME	APPROVED		Fuji Electric Co.,Ltd.		
DRAWN	Mar./8/'17	<i>Y. Hara</i>	<i>Y. Hara</i>		MS5F9141		
CHECKED	Mar./8/'17	<i>T. Hara</i>					
CHECKED	Mar./8/'17	<i>J. Hara</i>					
				DWG.NO.	1/16		

Revised Records

Date	Classification	Index	Content	Drawn	Checked	Checked	Approved
Mar.-8 -2017	Enactment	----	----	Y. Hara	<i>T. Wakatsuki</i>	<i>J. Hasegawa</i>	<i>Y. Ota</i>

This material and the information herein is the property of Fuji Electric Co., Ltd. They shall be neither reproduced, copied, lent, or disclosed in any way whatsoever for the use of any third party nor used for the manufacturing purposes without the express written consent of Fuji Electric Co., Ltd.

This material and the information herein is the property of Fuji Electric Co.,Ltd. They shall be neither reproduced, copied, lent, or disclosed in any way whatsoever for the use of any third party nor used for the manufacturing purposes without the express written consent of Fuji Electric Co.,Ltd.

1. **Scope** This specifies Fuji Discrete IGBT FGW75N60WQ
2. **Construction** IGBT in Trench gate Field stop technology with Ultra FWD
3. **Applications** Uninterrupted Power Supply, PV Power Conditioner, Inverter welding machine
4. **Features** Pb-free lead terminal; RoHS compliant
5. **Key Characteristics**

Parameter	Value	Unit
V_{CE}	600	V
$I_C (T_j = 100^\circ\text{C})$	75	A
$V_{CE(\text{sat}), \text{typ}} (T_j = 25^\circ\text{C})$	1.95	V
$T_{j(\text{max})}$	175	$^\circ\text{C}$

6. **Package and Internal circuit chart**

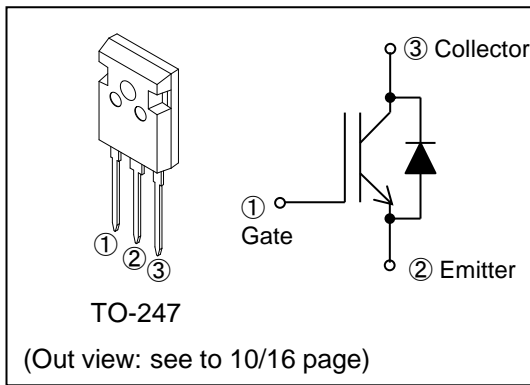

7. **Absolute Maximum Ratings at $T_j = 25^\circ\text{C}$ (unless otherwise specified)**

Parameter	Symbol	Value	Unit	Remarks
Collector-Emitter Voltage	V_{CES}	600	V	
Gate-Emitter Voltage	V_{GES}	± 20	V	$t_p < 1 \mu\text{s}$
Transient Gate-Emitter Voltage		± 30		
DC Collector Current	$I_{C@25}$	113	A	$T_c = 25^\circ\text{C}$
	$I_{C@100}$	75	A	$T_c = 100^\circ\text{C}$
Pulsed Collector Current	I_{CP}	225	A	Note *1
Turn-Off Safe Operating Area	-	225	A	$V_{CE} \leq 600 \text{ V}$ $T_j \leq 175^\circ\text{C}$
Diode Forward Current	$I_F@25$	20	A	
	$I_F@100$	14	A	
Diode Pulsed Current	I_{FP}	120	A	Note *1
IGBT Max. Power Dissipation	$P_{\text{tot_IGBT}}$	405	W	$T_c = 25^\circ\text{C}$
FWD Max. Power Dissipation	$P_{\text{tot_FWD}}$	52	W	$T_c = 25^\circ\text{C}$
Operating Junction Temperature	T_j	-40 ~ +175	$^\circ\text{C}$	
Storage Temperature	T_{stg}	-55 ~ +175	$^\circ\text{C}$	

Note

*1 : Pulse width limited by $T_{j \text{ max}}$

8. Electrical Characteristics at $T_j = 25\text{ }^\circ\text{C}$ (unless otherwise specified)

Static characteristics

Parameter	Symbol	Conditions	Min.	Typ.	Max.	Unit	
Zero Gate Voltage Collector Current	I_{CES}	$V_{CE} = 600\text{ V}$ $V_{GE} = 0\text{ V}$	$T_j = 25\text{ }^\circ\text{C}$	-	-	250	μA
			$T_j = 175\text{ }^\circ\text{C}$	-	-	2	mA
Gate-Emitter Leakage Current	I_{GES}	$V_{CE} = 0\text{ V}$ $V_{GE} = \pm 20\text{ V}$	-	-	200	nA	
Gate-Emitter Threshold Voltage	$V_{GE(th)}$	$V_{CE} = 20\text{ V}$ $I_C = 75\text{ mA}$	3.0	4.0	5.0	V	
Collector-Emitter Saturation Voltage	$V_{CE(sat)}$	$V_{GE} = 15\text{ V}$ $I_C = 75\text{ A}$	$T_j = 25\text{ }^\circ\text{C}$	1.35	1.95	2.55	V
			$T_j = 175\text{ }^\circ\text{C}$	-	2.3	-	

Dynamic characteristics

Parameter	Symbol	Conditions	Min.	Typ.	Max.	Unit
Input Capacitance	C_{ies}	$V_{CE} = 25\text{ V}$ $V_{GE} = 0\text{ V}$ $f = 1\text{ MHz}$	2150	4300	6450	pF
Output Capacitance	C_{oes}		63	125	188	
Reverse Transfer Capacitance	C_{res}		48	95	143	
Gate Charge	Q_G	$V_{CC} = 400\text{ V}$ $I_C = 75\text{ A}$ $V_{GE} = 15\text{ V}$	125	250	375	nC
Turn-On Delay Time	$t_{d(on)}$	$T_j = 25\text{ }^\circ\text{C}$ $V_{CC} = 400\text{ V}$ $I_C = 37.5\text{ A}$ $V_{GE} = 15\text{ V}$ $R_G = 10\ \Omega$ Energy loss include "tail" and FWD reverse recovery.	14	28	42	ns
Rise Time	t_r		23	46	69	
Turn-Off Delay Time	$t_{d(off)}$		125	250	375	
Fall Time	t_f		37	74	111	mJ
Turn-On Energy	E_{on}		0.32	0.65	0.97	
Turn-Off Energy	E_{off}		0.44	0.88	1.32	
Turn-On Delay Time	$t_{d(on)}$	$T_j = 150\text{ }^\circ\text{C}$ $V_{CC} = 400\text{ V}$ $I_C = 37.5\text{ A}$ $V_{GE} = 15\text{ V}$ $R_G = 10\ \Omega$ Energy loss include "tail" and FWD reverse recovery.	14	28	42	ns
Rise Time	t_r		22	43	65	
Turn-Off Delay Time	$t_{d(off)}$		140	280	420	
Fall Time	t_f		26	52	78	mJ
Turn-On Energy	E_{on}		0.42	0.85	1.27	
Turn-Off Energy	E_{off}		0.45	0.90	1.35	

This material and the information herein is the property of Fuji Electric Co., Ltd. They shall be neither reproduced, copied, lent, or disclosed in any way whatsoever for the use of any third party nor used for the manufacturing purposes without the express written consent of Fuji Electric Co., Ltd.

FWD Characteristics

Parameter	Symbol	Conditions	min.	typ.	max.	Unit	
Forward Voltage Drop	V_F	$I_F = 14 \text{ A}$	$T_j = 25 \text{ }^\circ\text{C}$	1.64	2.60	3.56	V
			$T_j = 175 \text{ }^\circ\text{C}$	-	1.80	-	V
Diode Reverse Recovery Time	t_{rr}	$V_{CC} = 400 \text{ V}$ $I_F = 10 \text{ A}$ $-di_F/dt = 500 \text{ A}/\mu\text{s}$ $T_j = 25 \text{ }^\circ\text{C}$	43	86	129	ns	
Diode Reverse Recovery Charge	Q_{rr}		0.08	0.17	0.25	μC	
Diode Reverse Recovery Time	t_{rr}	$V_{CC} = 400 \text{ V}$ $I_F = 10 \text{ A}$ $-di_F/dt = 500 \text{ A}/\mu\text{s}$ $T_j = 150 \text{ }^\circ\text{C}$	50	100	150	ns	
Diode Reverse Recovery Charge	Q_{rr}		0.26	0.53	0.79	μC	

9. Thermal Resistance

Parameter	Symbol	Min.	Typ.	Max.	Unit
Thermal Resistance, Junction-Ambient	$R_{th(j-a)}$	-	-	50	$^\circ\text{C}/\text{W}$
Thermal Resistance, IGBT Junction to Case	$R_{th(j-c)}_{IGBT}$	-	-	0.366	$^\circ\text{C}/\text{W}$
Thermal Resistance, FWD Junction to Case	$R_{th(j-c)}_{FWD}$	-	-	2.907	$^\circ\text{C}/\text{W}$

This material and the information herein is the property of Fuji Electric Co., Ltd. They shall be neither reproduced, copied, lent, or disclosed in any way whatsoever for the use of any third party nor used for the manufacturing purposes without the express written consent of Fuji Electric Co., Ltd.

10. Test circuits

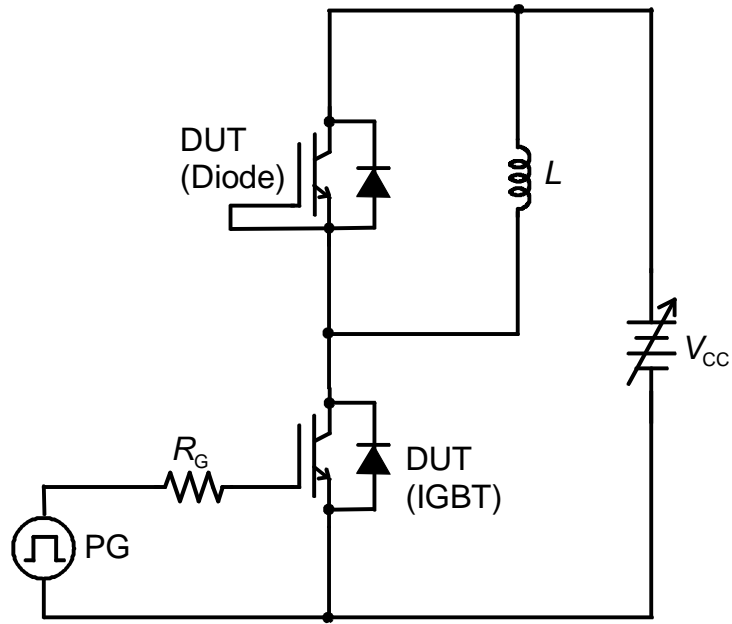

Figure 1. Switching test circuit

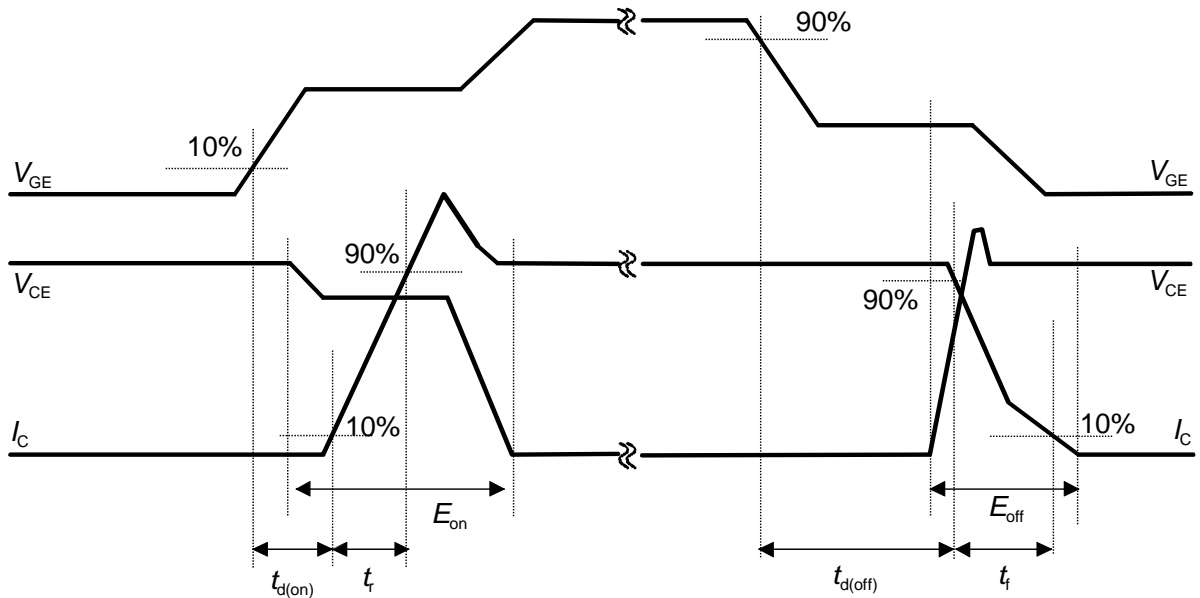

Figure 2. Switching times waveforms

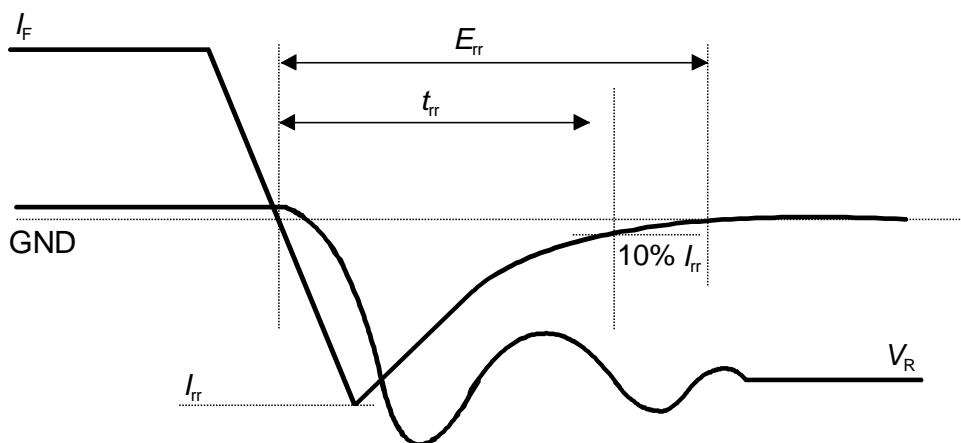

Figure 3 : Switching waveforms

This material and the information herein is the property of Fuji Electric Co., Ltd. They shall be neither reproduced, copied, lent, or disclosed in any way whatsoever for the use of any third party nor used for the manufacturing purposes without the express written consent of Fuji Electric Co., Ltd.

11. Characteristics curve

Figure 4. DC Collector Current vs T_c
 $V_{GE} \geq +15\text{ V}$, $T_j \leq 175\text{ }^\circ\text{C}$

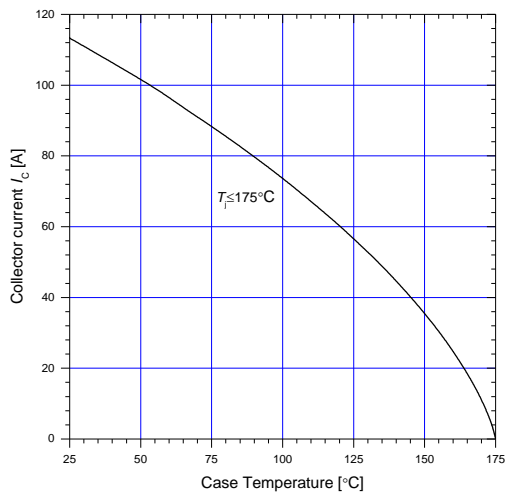

Figure 5. SOA
 Duty=0, $T_c=25\text{ }^\circ\text{C}$

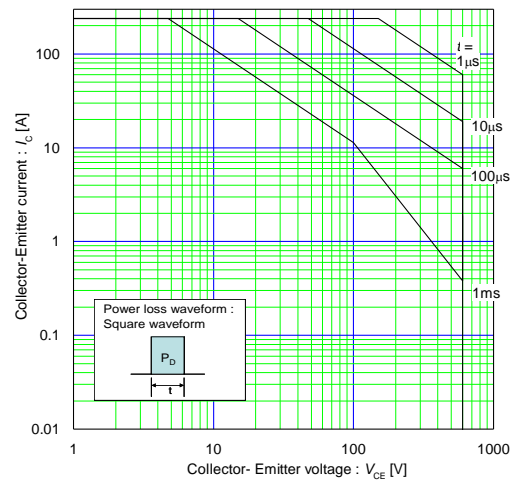

Figure 6. Typical output characteristics
 $T_j = 25\text{ }^\circ\text{C}$

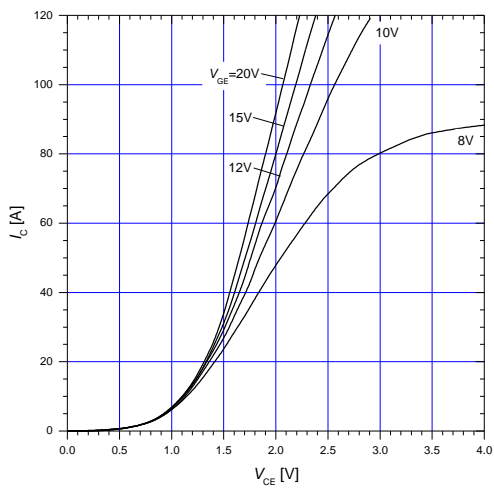

Figure 7. Typical output characteristics
 $T_j = 175\text{ }^\circ\text{C}$

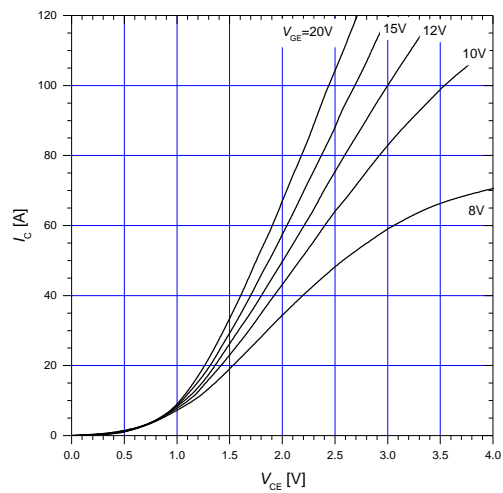

Figure 8. Typical transfer characteristics
 $V_{CE} = 10\text{ V}$

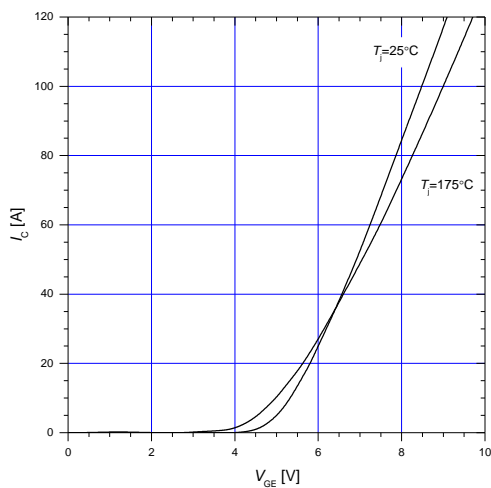
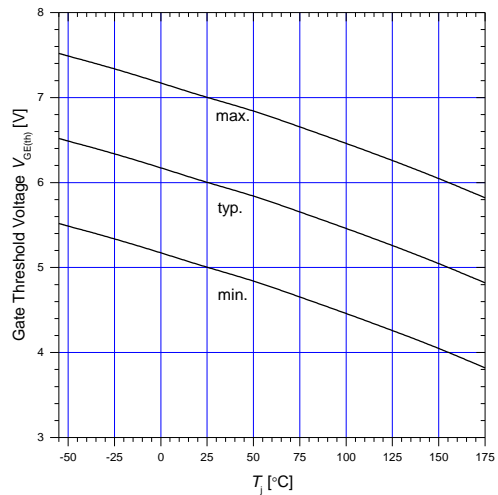

Figure 9. Gate threshold voltage
 $I_C = 75\text{ mA}$, $V_{CE} = 20\text{ V}$



This material and the information herein is the property of Fuji Electric Co.,Ltd. They shall be neither reproduced, copied, lent, or disclosed in any way whatsoever for the use of any third party nor used for the manufacturing purposes without the express written consent of Fuji Electric Co.,Ltd.

This material and the information herein is the property of Fuji Electric Co., Ltd. They shall be neither reproduced, copied, lent, or disclosed in any way whatsoever for the use of any third party nor used for the manufacturing purposes without the express written consent of Fuji Electric Co., Ltd.

Figure 10. Typical capacitance

$V_{GE} = 0 \text{ V}, f = 1 \text{ MHz}$

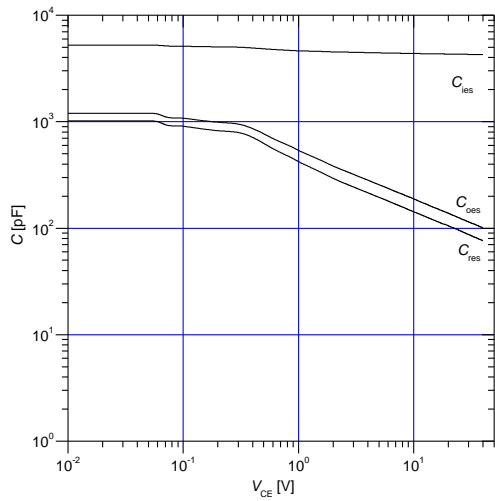

Figure 11. Typical gate charge

$I_C = 75 \text{ A}, V_{CC} = 520 \text{ V}, T_j = 25 \text{ }^\circ\text{C}$

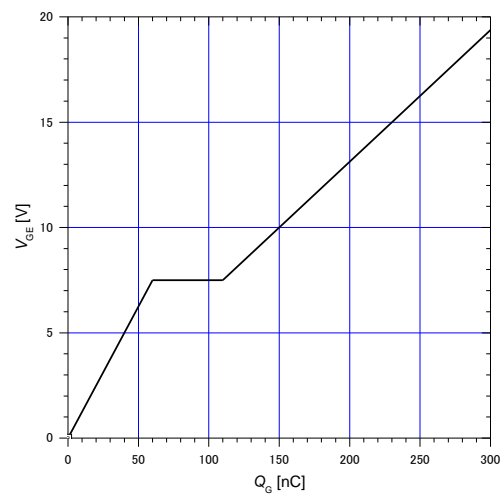

Figure 12. Typical switching times vs. I_C

$V_{CC} = 400 \text{ V}, V_{GE} = 15 \text{ V}, R_G = 10 \text{ } \Omega, T_j = 150 \text{ }^\circ\text{C}$

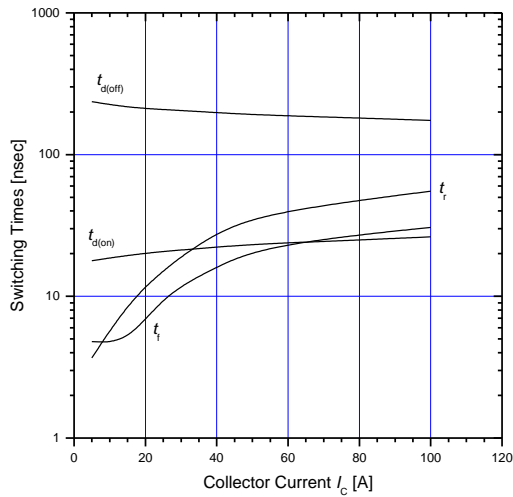

Figure 13. Typical switching times vs. R_G

$V_{CC} = 400 \text{ V}, V_{GE} = 15 \text{ V}, I_C = 37.5 \text{ A}, T_j = 150 \text{ }^\circ\text{C}$

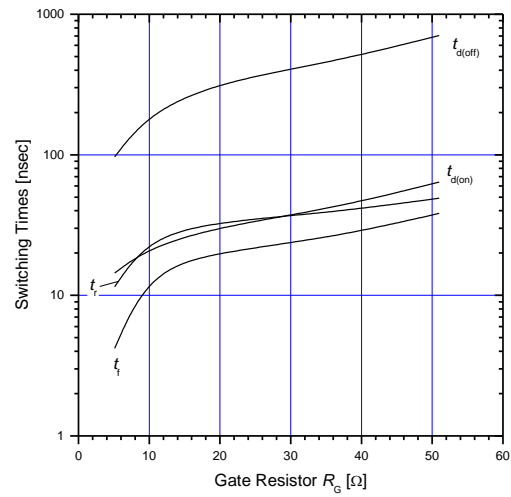

Figure 14. Typical switching losses vs. I_C

$V_{CC} = 400 \text{ V}, V_{GE} = 15 \text{ V}, R_G = 10 \text{ } \Omega, T_j = 150 \text{ }^\circ\text{C}$

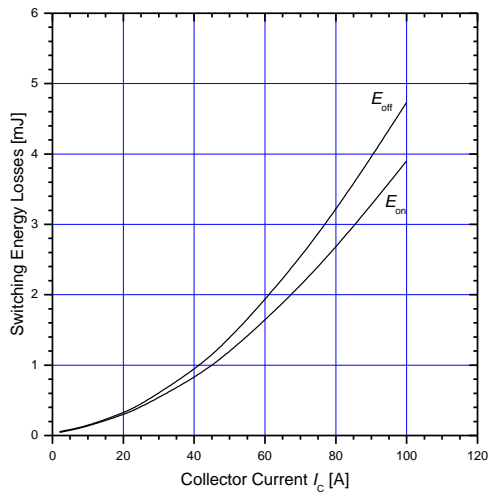
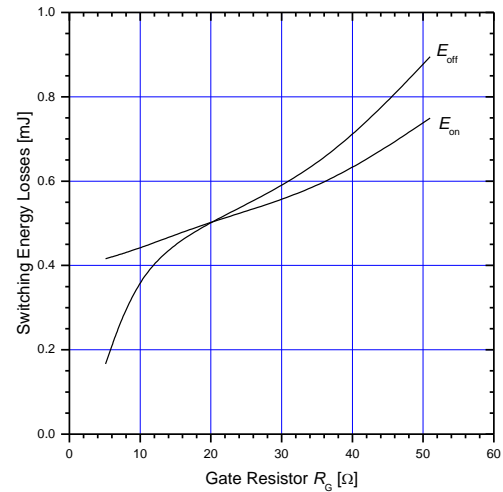

Figure 15. Typical switching losses vs. R_G

$V_{CC} = 400 \text{ V}, V_{GE} = 15 \text{ V}, I_C = 37.5 \text{ A}, T_j = 150 \text{ }^\circ\text{C}$



This material and the information herein is the property of Fuji Electric Co.,Ltd. They shall be neither reproduced, copied, lent, or disclosed in any way whatsoever for the use of any third party nor used for the manufacturing purposes without the express written consent of Fuji Electric Co.,Ltd.

Figure 16. Typical forward characteristics of FWD

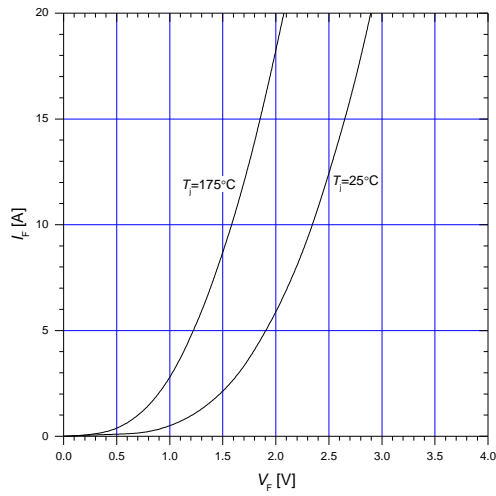

Figure 17. Typical reverse recovery characteristics vs. I_F
 $V_{CC} = 400$ V, $V_{GE} = 15$ V, $R_G = 10$ Ω , $T_j = 150$ $^\circ\text{C}$

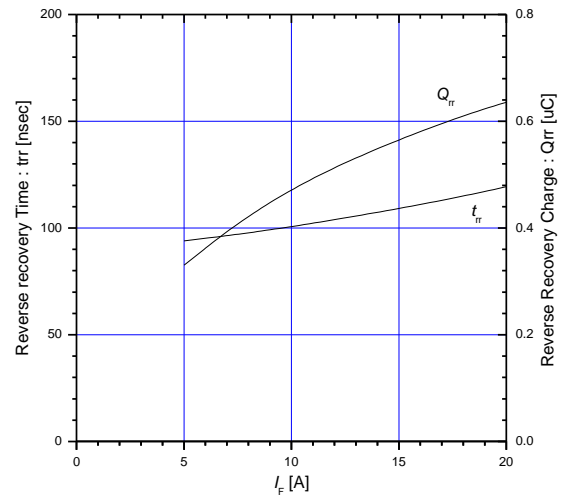

Figure 18. Typical reverse recovery loss vs. I_F

$V_{CC} = 400$ V, $V_{GE} = 15$ V, $R_G = 10$ Ω , $T_j = 150$ $^\circ\text{C}$

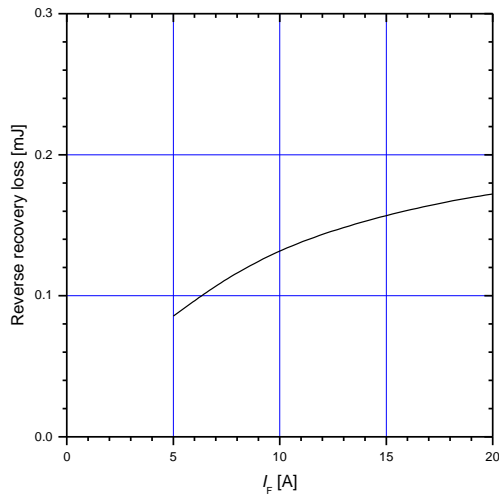

Figure 19. Reverse biased safe operating area

$V_{GE} = 15$ V / 0 V, $R_G = 10$ Ω , $T_j \leq 175$ $^\circ\text{C}$

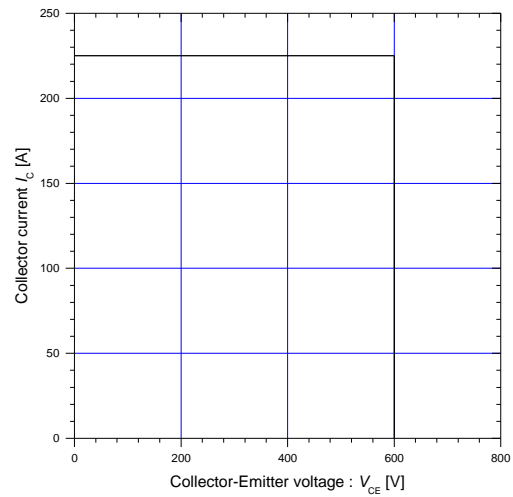

Figure 20. Transient Thermal Impedance of IGBT
 $D = 0$

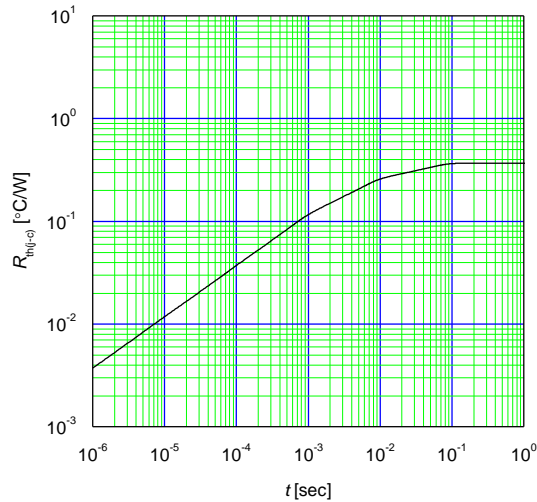
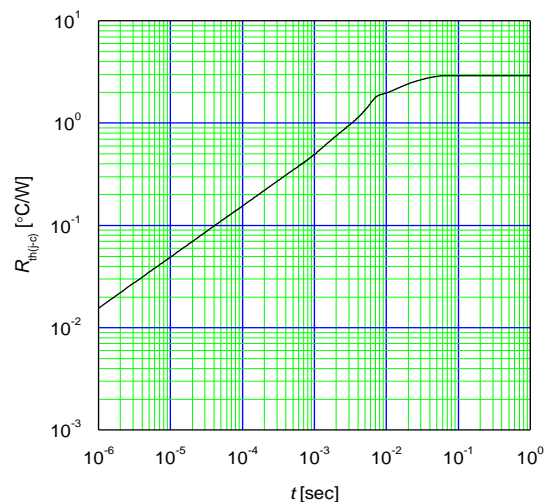
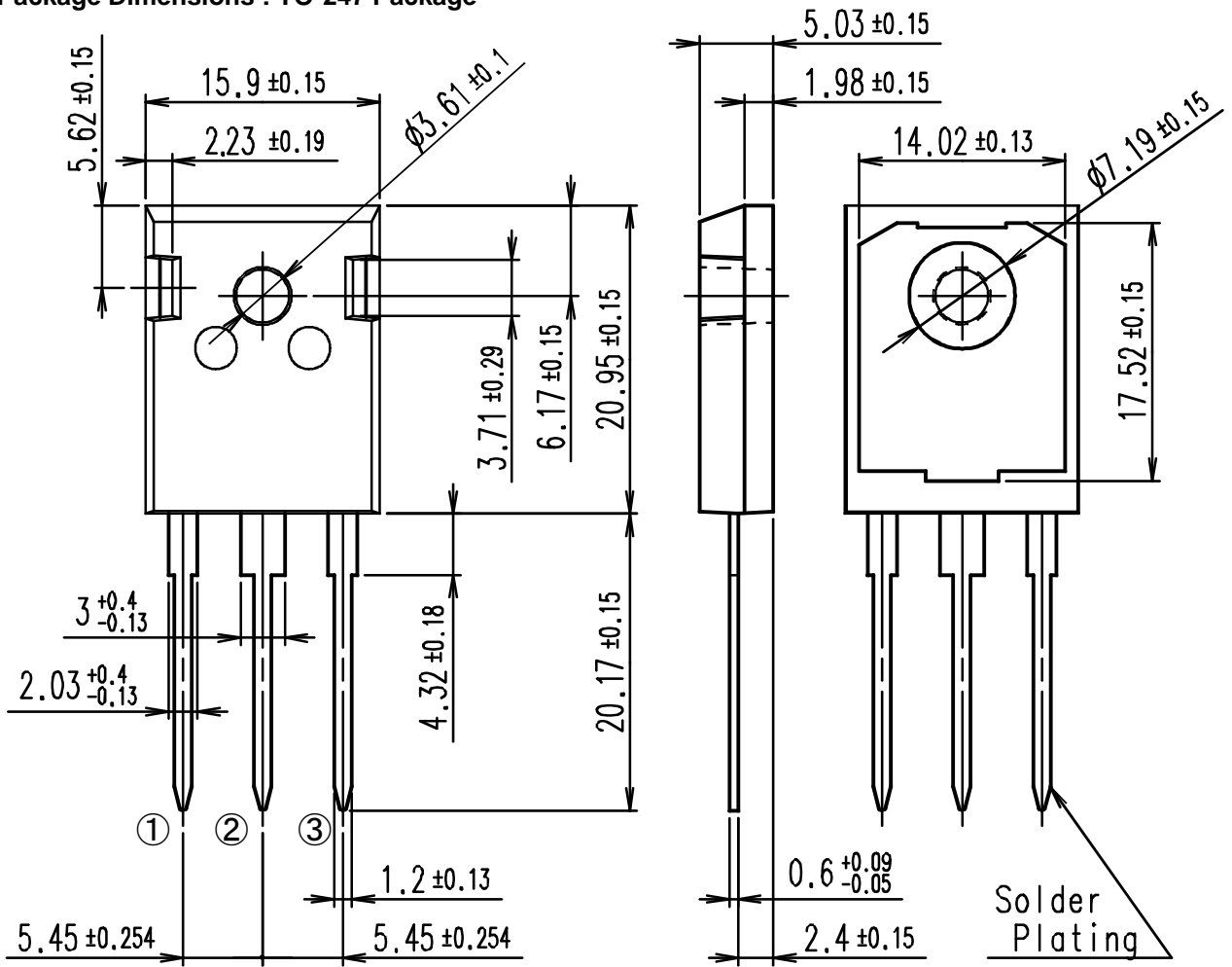

Figure 21. Transient Thermal Impedance of FWD
 $D = 0$



12. Package out view

Package Dimensions : TO-247 Package



CONNECTION

- ① GATE
- ② COLLECTOR
- ③ EMITTER

DIMENSIONS ARE IN MILLIMETERS.

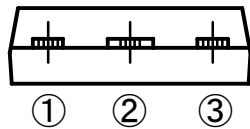

Marking

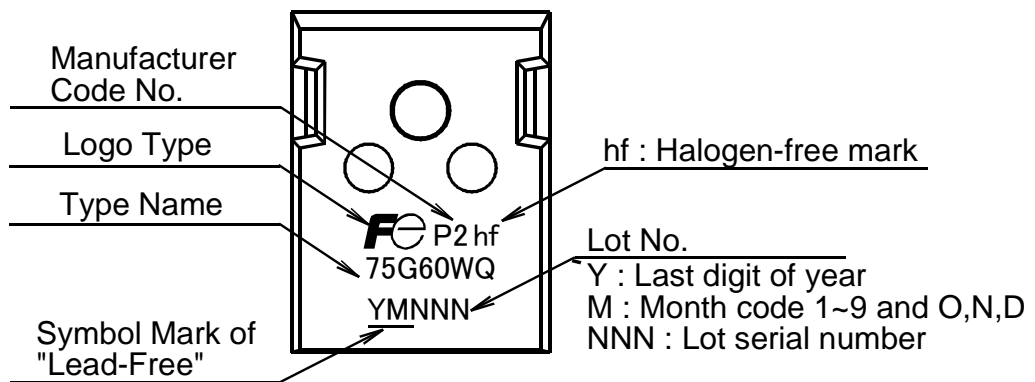

* The font (font type, size) and the logo type size might be actually different.

This material and the information herein is the property of Fuji Electric Co., Ltd. They shall be neither reproduced, copied, lent, or disclosed in any way whatsoever for the use of any third party nor used for the manufacturing purposes without the express written consent of Fuji Electric Co., Ltd.

Fuji Electric Co., Ltd.

DWG. NO.

MS5F9141

10/16

H04-004-03

13. Reliability test items

All guaranteed values are under the categories of reliability per non-assembled (only IGBTs).
Each categories under the guaranteed reliability conform to JEITA ED4701/100A method104A standards.

- Baking treatment ($125 \pm 5 \text{ }^\circ\text{C}$, 24 hr)
- Humidification treatment ($85 \pm 2 \text{ }^\circ\text{C}$, $85 \pm 5 \text{ \%RH}$, $168 \pm 24 \text{ hr}$)
- Heat treatment of soldering (Solder Dipping, $260 \pm 5 \text{ }^\circ\text{C}$ ($265 \text{ }^\circ\text{C}$ max.), $10 \pm 1 \text{ sec.}$, 2 times)

	Test No.	Test items	Testing methods and conditions	Reference standard	Sampling number	Acceptance number
Mechanical test methods	1	Terminal strength (Pull)	Pull force TO-247 : 25 N Force maintaining duration : $30 \pm 5 \text{ sec.}$	JEITA ED4701/400A method 401A	15	(0:1)
	2	Terminal strength (Bending)	Load force TO-247 : 10 N Number of times : 2 times (90 deg./time)	JEITA ED4701/400A method 401A	15	
	3	Terminal strength (Fatigue)	Load force TO-247 : 10 N Number of times : 3 times (15 deg./time)	JEITA ED4701/400A method 401A	15	
	4	Mounting strength	Screwing torque value: (M3) TO-247 : $50 \pm 10 \text{ N}\cdot\text{cm}$	JEITA ED4701/400A method 402	15	
	5	Solderability	Solder temp. : $245 \pm 5 \text{ }^\circ\text{C}$ Immersion time : $5 \pm 0.5 \text{ sec.}$ Each terminal shall be immersed in the solder bath within 1 to 1.5 mm from the body.	JEITA ED4701/301 method 303A	15	
	6	Resistance to soldering heat	Solder temp. : $270 \pm 5 \text{ }^\circ\text{C}$ Immersion time : $7 +2 / -0 \text{ sec.}$ Number of times : 1 time	JEITA ED4701/301 method 302A	15	

This material and the information herein is the property of Fuji Electric Co.,Ltd. They shall be neither reproduced, copied, lent, or disclosed in any way whatsoever for the use of any third party nor used for the manufacturing purposes without the express written consent of Fuji Electric Co.,Ltd.

This material and the information herein is the property of Fuji Electric Co.,Ltd. They shall be neither reproduced, copied, lent, or disclosed in any way whatsoever for the use of any third party nor used for the manufacturing purposes without the express written consent of Fuji Electric Co.,Ltd.

	Test No.	Test items	Testing methods and conditions	Reference standard	Sampling number	Acceptance number
Climatic test methods	7	High temperature Storage	Temperature : 175 + 0 / - 5 °C Test duration : 1000 hr	JEITA ED4701/200A method 201A	22	(0:1)
	8	Low temperature storage	Temperature : -55 + 5 / - 0 °C Test duration : 1000 hr	JEITA ED4701/200A method 202A	22	
	9	Temperature humidity storage	Temperature : 85 ± 2 °C Relative humidity : 85 ± 5 % Test duration : 1000 hr	JEITA ED4701/100A method 103A	22	
	10	Temperature humidity bias	Temperature : 85 ± 2 °C Relative humidity : 85 ± 5 % Bias voltage : $V_{CE(max)} * 0.8$ Test duration : 1000 hr	JEITA ED4701/100A method 102A	22	
	11	Unsaturated pressure cooker	Temperature : 130 ± 2 °C Relative humidity : 85 ± 5 % Vapor pressure : 230 kPa Test duration : 48 hr	JEITA ED4701/100A method 103A	22	
	12	Temperature cycle	High temp. side : 175 + 15 / - 0 °C / 15min. Low temp. side : - 55 + 0 / -10 °C / 15min. RT : 5 °C ~ 35 °C / 5 min. Number of cycles : 100 cycles	JEITA ED4701/100A method 105A	22	
	13	Thermal shock	Fluid : Perfluorocarbon High temp. side : 100 + 10 / - 2 °C Low temp. side : 0 + 2 / - 10 °C Duration time : HT 5 min., LT 5 min. Number of cycles : 100 cycles	JEITA ED4701/302 method 307B	22	
Endurance test methods	14	Intermittent operating life	$\Delta T_c = 90 \text{ }^\circ\text{C}$ $T_j \leq T_{j(max)}$ Test duration : 3000 cycles	JEITA ED4701/100A method 106A	22	(0:1)
	15	High temperature gate bias	Temperature : $T_j = 175 + 0 / - 5 \text{ }^\circ\text{C}$ Bias voltage : + $V_{GE(max)}$ Test duration : 1000 hr	JEITA ED4701/100A method 101A	22	
	16	High temperature reverse bias	Temperature : $T_j = 175 + 0 / - 5 \text{ }^\circ\text{C}$ Bias voltage : $V_{CE(max)} * 0.8$ Test duration : 1000 hr	JEITA ED4701/100A method 101A	22	

Failure Criteria

	Item	Symbols	Failure criteria		Unit
			Lower limit	Upper limit	
Electrical characteristics	Zero gate Voltage Collector-Emitter Current	I_{CES}	-----	USL	A
	Gate-Emitter Leakage Current	I_{GES}	-----	USL	A
	Gate Threshold Voltage	$V_{GE(th)}$	LSL	USL	V
	Collector-Emitter saturation Voltage	$V_{CE(sat)}$	-----	USL	V
	Forward voltage drop	V_F	-----	USL	V
Out view	Marking, Soldering and other damages	-----	With eyes or Microscope		-----

* LSL : Lower Specification Limit * USL : Upper Specification Limit

Fuji Electric Co.,Ltd.

DWG.NO.

MS5F9141

12/16

H04-004-03

14. Warnings

- You must design and use the IGBTs to be operated within the specified maximum ratings (voltage, current, temperature, etc.).
- You must design and use the IGBTs by the following conditions. (Please refer to Figure A)
The steady state voltage must be 80 % or less to the specified maximum ratings.
The worst-case voltage (including surge) must be under the specified maximum ratings.
- It shall be confirmed that IGBT's operating locus of the turn-off voltage and current are within the RBSOA specification. This product may be broken if the locus is out of the RBSOA..
- This product may be broken by avalanche in case of V_{CE} beyond maximum rating V_{CES} is applied between C-E terminals. Use this product within its maximum
- Consider the possible temperature rise not only for the channel and case, but also for the outer leads.
- The IGBTs may be destroyed if you design and use beyond the rating.
- The equipment containing IGBTs should have adequate fuses or circuit breakers to prevent the equipment from causing secondary destruction (ex. fire, explosion etc...).
- Use the IGBTs within their reliability and lifetime under certain environments or conditions.
The IGBTs may fail before the target lifetime of your products if used under certain reliability conditions.
- Be careful when handling IGBTs for ESD damage. (It is an important consideration.)
- When handling IGBTs, hold them by the case (package) and don't touch the leads and terminals.
- It is recommended that any handling of IGBTs is done on grounded electrically conductive floor and tablemats.
- Before touching a IGBT terminal, Discharge any static electricity from your body and clothes by grounding out through a high impedance resistor (about 1 Mohm).
- When soldering, in order to protect the IGBTs from static electricity, ground the soldering iron or soldering bath through a low impedance resistor.
- Do not directly touch the leads or package of the IGBTs while power is supplied or during operation in order to avoid electric shock and burns.
- The IGBTs are made of incombustible material. However, if a IGBT fails, it may emit smoke or flame. Also, operating the IGBTs near any flammable place or material may cause the IGBTs to emit smoke or flame in case the IGBTs become even hotter during operation. Design the arrangement to prevent the spread of fire.
- The IGBTs should not used in an environment in the presence of acid, organic matter, or corrosive gas (hydrogen sulfide, sulfurous acid gas etc.)
- The IGBTs should not used in an irradiated environment since they are not radiation-proof.

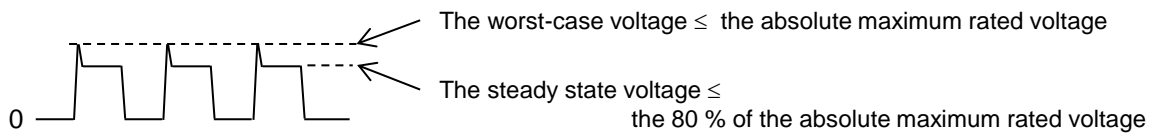

Figure A. The operating voltage waveform of the switching

This material and the information herein is the property of Fuji Electric Co.,Ltd. They shall be neither reproduced, copied, lent, or disclosed in any way whatsoever for the use of any third party nor used for the manufacturing purposes without the express written consent of Fuji Electric Co.,Ltd.

15. Cautions

- Although Fuji Electric is continually improving product quality and reliability, a small percentage of semiconductor products may become faulty. When using Fuji Electric semiconductor products in your equipment, you are requested to take adequate safety measures to prevent the equipment from causing physical injury, fire, or other problem in case any of the products fail. It is recommended to make your design fail-safe, flame retardant, and free of malfunction.
- The products described in this Specification are intended for use in the following electronic and electrical equipment which has normal reliability requirements.
 - Computers
 - Machine tools
 - Personal equipment
 - OA equipment
 - AV equipment
 - Industrial robots
 - Communications equipment (Terminal devices)
 - Measurement equipment
 - Electrical home appliances etc.
- The products described in this Specification are not designed or manufactured to be used in equipment or systems used under life-threatening situations. If you are considering using these products in the equipment listed below, first check the system construction and required reliability, and take adequate safety measures such as a backup system to prevent the equipment from malfunctioning.
 - Backbone network equipment
 - Traffic-signal control equipment
 - Submarine repeater equipment
 - Medical equipment
 - Transportation equipment(automobiles, trains, ships, etc.)
 - Gas alarms, leakage gas auto breakers
 - Burglar alarms, fire alarms, emergency equipment
 - Nuclear control equipment etc.
- Do not use the products in this Specification for equipment requiring strict reliability such as (but not limited to):
 - Aerospace equipment
 - Aeronautical equipment

Storage

- The IGBTs should be stored at a standard temperature of 5 to 35 °C and relative humidity of 45 to 75 %.
- If the storage area is very dry, a humidifier may be required. In such a case, use only deionized water or boiled water, since the chlorine in tap water may corrode the leads.
- The IGBTs should not be subjected to rapid changes in temperature to avoid condensation on the surface of the IGBTs. Therefore store the IGBTs in a place where the temperature is steady.
- The IGBTs should not be stored on top of each other, since this may cause excessive external force on the case.
- The IGBTs should be stored with the lead terminals remaining unprocessed. Rust may cause pre-soldered connections to fail during later processing.
- The IGBTs should be stored in antistatic containers or shipping bags.

Installation

- Soldering involves temperatures which exceed the device storage temperature rating. To avoid device damage and to ensure reliability, observe the following guidelines from the quality assurance standard.
- The immersion depth of the lead should basically be up to the lead stopper and the distance should be a maximum of 1.5 mm from the device.
- When wave-soldering, be careful to avoid immersing the package in the solder bath.

Recommended soldering methods

Category	Package	Soldering Methods				
		Wave Soldering (Full dipping)	Wave Soldering (Only terminal)	Infrared Reflow	Air Reflow	Soldering iron (Re-work)
Through hole package	TO-247	U	P2	U	U	P1

P2: Possible (within 2 times) P1: Possible (Only 1 time) U: Unable

Solder temperature and duration

Category	Methods	Soldering Peak Temp. & Time
Through hole package	Wave soldering	260 ± 5 °C, 10 ± 1 sec.
	Soldering iron (Re-work)	350 ± 10 °C, 3.5 ± 0.5 sec.

- Refer to the following torque reference when mounting the device on a heat sink. Excess torque applied to the mounting screw causes damage to the device and weak torque will increase the thermal resistance, both of which conditions may destroy the device.
- The heat sink should have a flatness within ± 30 μm and roughness within 10 μm. Also, keep the tightening torque within the limits of this specification.
- Improper handling may cause isolation breakdown leading to a critical accident.
ex.) Over plane off the edges of screw hole. (Recommended plane off the edge is $C \leq 1.0$ mm)
- We recommend the use of thermal compound to optimize the efficiency of heat radiation. It is important to evenly apply the compound and to eliminate any air voids.

Recommended tightening torques (Through hole package)

Packages	Screw	Tightening torques	Note
TO-247	M3	40 – 60 Ncm	flatness : $\leq \pm 30 \mu\text{m}$ roughness : $\leq 10 \mu\text{m}$ Plane off the edge : $C \leq 1.0$ mm

This material and the information herein is the property of Fuji Electric Co.,Ltd. They shall be neither reproduced, copied, lent, or disclosed in any way whatsoever for the use of any third party nor used for the manufacturing purposes without the express written consent of Fuji Electric Co.,Ltd.

This material and the information herein is the property of Fuji Electric Co.,Ltd. They shall be neither reproduced, copied, lent, or disclosed in any way whatsoever for the use of any third party nor used for the manufacturing purposes without the express written consent of Fuji Electric Co.,Ltd.

16. Compliance with pertaining to restricted substances

16-1) Compliance with the RoHS Regulations and Exemptions

- This product will be fully compliant with the RoHS directive. (Directive 2011/65/EC of the European Parliament and the Council of 21 July 2011).
- All of six substances below which are regulated by the RoHS directive in Europe are not included in this product.
 - * The six substances regulated by the RoHS Directive are:
Lead, Mercury, Hexavalent chromium, Cadmium, PBB (polybrominated biphenyls),
PBDE (polybrominated diphenyl ethers).
- The maximum concentration value of the six substances in this product conforms to the Commission decision 2005/618/EC of EU of 19 August 2005.

16-2) Compliance with the class-1 ODS and class-2 ODS. (ODS: Ozone-Depleting Substances)

- This product does not contain and used the "Law concerning the Protection of the Ozone Layer through the Control of Specified Substances and Other Measures (JAPAN)", and the Montreal Protocol.

- If you have any questions about any part of this Specification, please contact Fuji Electric or its sales agent before using the product.
- Neither Fuji nor its agents shall be held liable for any injury caused by using the products not in accordance with the instructions.
- The application examples described in this specification are merely typical uses of Fuji Electric products.
- This specification does not confer any industrial property rights or other rights, nor constitute a license for such rights.