

General Description

OST50N65HSZF uses advanced Oriental-Semi's patented Trident-Gate Bipolar Transistor (TGBT™) technology to provide extremely low $V_{CE(sat)}$, low gate charge, and excellent switching performance. This device is suitable for mid to high range switching frequency converters.

Features

- Advanced TGBT™ technology
- Excellent conduction and switching loss
- Excellent stability and uniformity
- Fast and soft antiparallel diode



Applications

- Induction converters
- Uninterruptible power supplies

Key Performance Parameters

Parameter	Value	Unit
$V_{CES, min}$ @ 25 °C	650	V
Maximum junction temperature	175	°C
$I_C, pulse$	200	A
$V_{CE(sat), typ}$ @ $V_{GE}=15$ V	1.45	V
Q_g	110	nC

Marking Information

Product Name	Package	Marking
OST50N65HSZF	TO247	OST50N65HSZ

Package & Pin Information



Absolute Maximum Ratings at $T_{vj}=25\text{ °C}$ unless otherwise noted

Parameter	Symbol	Value	Unit
Collector emitter voltage	V_{CES}	650	V
Gate emitter voltage	V_{GES}	± 20	V
Transient gate emitter voltage, $T_P \leq 10\ \mu s$, $D < 0.01$		± 30	V
Continuous collector current ¹⁾ , $T_C = 25\text{ °C}$	I_C	80	A
Continuous collector current ¹⁾ , $T_C = 100\text{ °C}$		50	A
Pulsed collector current ²⁾ , $T_C = 25\text{ °C}$	$I_{C, pulse}$	200	A
Diode forward current ¹⁾ , $T_C = 25\text{ °C}$	I_F	80	A
Diode forward current ¹⁾ , $T_C = 100\text{ °C}$		50	A
Diode pulsed current ²⁾ , $T_C = 25\text{ °C}$	$I_{F, pulse}$	200	A
Power dissipation ³⁾ , $T_C = 25\text{ °C}$	P_D	305	W
Power dissipation ³⁾ , $T_C = 100\text{ °C}$		152	W
Operation and storage temperature	T_{stg}, T_{vj}	-55 to 175	°C
Short circuit withstand time $V_{GE} = 15\text{ V}$, $V_{CC} \leq 400\text{ V}$ Allowed number of short circuits < 1000 Time between short circuits: $\geq 1.0\text{ S}$ $T_{vj} = 150\text{ °C}$	t_{sc}	10	μs

Thermal Characteristics

Parameter	Symbol	Value	Unit
IGBT thermal resistance, junction-case	$R_{\theta JC}$	0.4	°C/W
Diode thermal resistance, junction-case	$R_{\theta JC}$	1.4	°C/W
Thermal resistance, junction-ambient ⁴⁾	$R_{\theta JA}$	40	°C/W

Electrical Characteristics at $T_{vj}=25\text{ °C}$ unless otherwise specified

Parameter	Symbol	Min.	Typ.	Max.	Unit	Test condition
Collector-emitter breakdown voltage	$V_{(BR)CES}$	650			V	$V_{GE}=0\text{ V}$, $I_C=0.5\text{ mA}$
Collector-emitter saturation voltage	$V_{CE(sat)}$		1.45	1.75	V	$V_{GE}=15\text{ V}$, $I_C=50\text{ A}$ $T_{vj}=25\text{ °C}$
			1.65		V	$V_{GE}=15\text{ V}$, $I_C=50\text{ A}$, $T_{vj}=125\text{ °C}$
			1.75			$V_{GE}=15\text{ V}$, $I_C=50\text{ A}$, $T_{vj}=175\text{ °C}$
Gate-emitter threshold voltage	$V_{GE(th)}$	3.5	4.5	5.5	V	$V_{CE}=V_{GE}$, $I_D=0.5\text{ mA}$
Diode forward voltage	V_F		1.3	1.6	V	$V_{GE}=0\text{ V}$, $I_F=50\text{ A}$ $T_{vj}=25\text{ °C}$
			1.25			$V_{GE}=0\text{ V}$, $I_F=50\text{ A}$, $T_{vj}=125\text{ °C}$
			1.25			$V_{GE}=0\text{ V}$, $I_F=50\text{ A}$, $T_{vj}=175\text{ °C}$
Gate-emitter leakage current	I_{GES}			100	nA	$V_{CE}=0\text{ V}$, $V_{GE}=20\text{ V}$
Zero gate voltage collector current	I_{CES}			10	μA	$V_{CE}=650\text{ V}$, $V_{GE}=0\text{ V}$

Dynamic Characteristics

Parameter	Symbol	Min.	Typ.	Max.	Unit	Test condition
Input capacitance	C_{ies}		5765		pF	$V_{GE}=0\text{ V}$, $V_{CE}=25\text{ V}$, $f=100\text{ kHz}$
Output capacitance	C_{oes}		740		pF	
Reverse transfer capacitance	C_{res}		4.2		pF	
Turn-on delay time	$t_{d(on)}$		78		ns	$V_{GE}=15\text{ V}$, $V_{CC}=400\text{ V}$, $R_G=10\ \Omega$, $I_C=50\text{ A}$
Rise time	t_r		105		ns	
Turn-off delay time	$t_{d(off)}$		130		ns	
Fall time	t_f		72		ns	
Turn-on energy	E_{on}		1.19		mJ	
Turn-off energy	E_{off}		0.74		mJ	
Turn-on delay time	$t_{d(on)}$		69		ns	$V_{GE}=15\text{ V}$, $V_{CC}=400\text{ V}$, $R_G=10\ \Omega$, $I_C=25\text{ A}$
Rise time	t_r		50		ns	
Turn-off delay time	$t_{d(off)}$		170		ns	
Fall time	t_f		67		ns	
Turn-on energy	E_{on}		0.48		mJ	
Turn-off energy	E_{off}		0.50		mJ	

Gate Charge Characteristics

Parameter	Symbol	Min.	Typ.	Max.	Unit	Test condition
Total gate charge	Q_g		110		nC	$V_{GE}=15\text{ V}$, $V_{CC}=520\text{ V}$, $I_C=50\text{ A}$
Gate-emitter charge	Q_{ge}		48.6		nC	
Gate-collector charge	Q_{gc}		18.5		nC	

Body Diode Characteristics

Parameter	Symbol	Min.	Typ.	Max.	Unit	Test condition
Diode reverse recovery time	t_{rr}		117		ns	$V_R=400\text{ V}$, $I_F=50\text{ A}$, $di_F/dt=300\text{ A}/\mu\text{s}$ $T_{vj}=25\text{ }^\circ\text{C}$
Diode reverse recovery charge	Q_{rr}		1.7		μC	
Diode peak reverse recovery current	I_{rrm}		25.8		A	

Note

- 1) Calculated continuous current based on maximum allowable junction temperature.
- 2) Repetitive rating; pulse width limited by max. junction temperature.
- 3) P_d is based on max. junction temperature, using junction-case thermal resistance.
- 4) The value of $R_{\theta JA}$ is measured with the device mounted on 1 in square FR-4 board with 2oz. Copper, in a still air environment with $T_a=25\text{ }^\circ\text{C}$.

Electrical Characteristics Diagrams

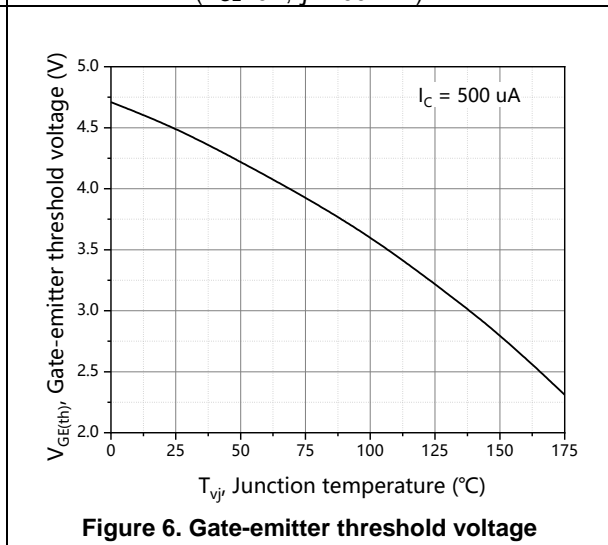
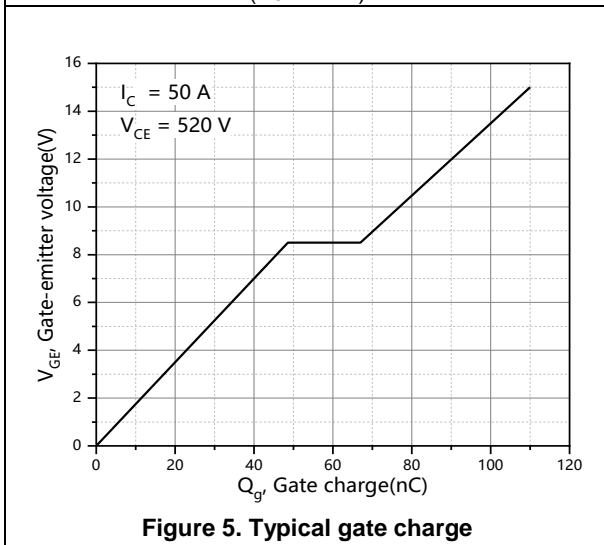
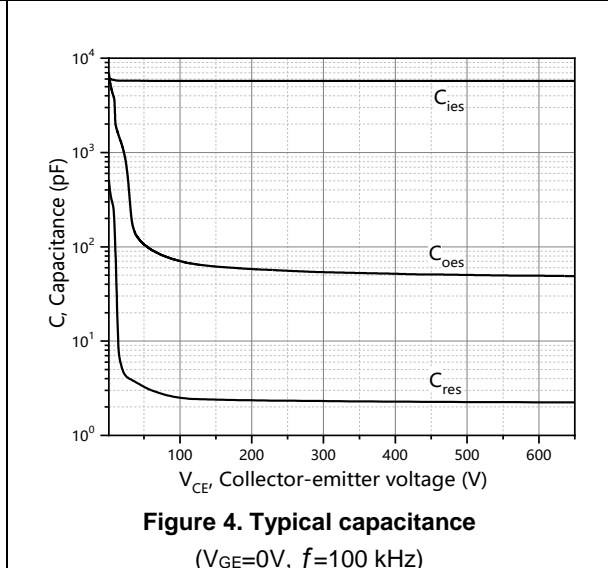
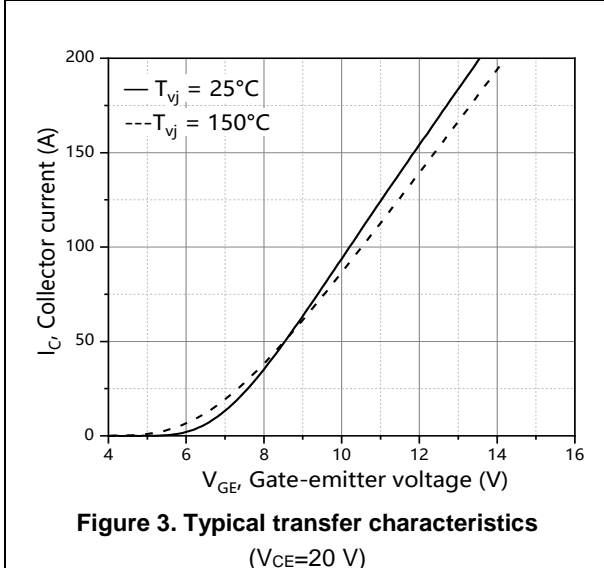
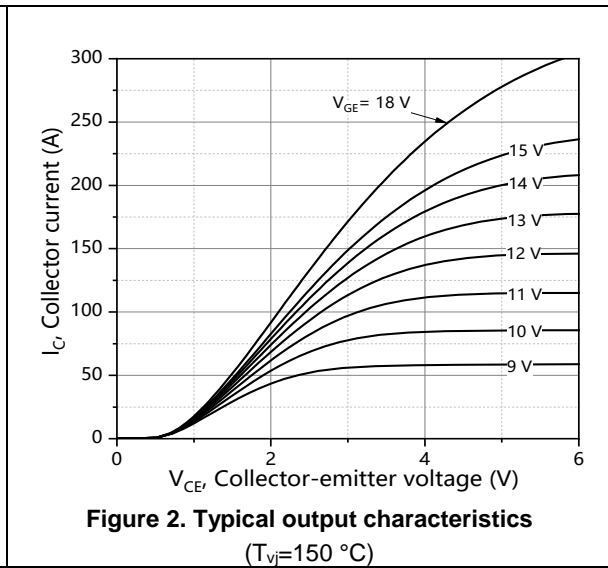
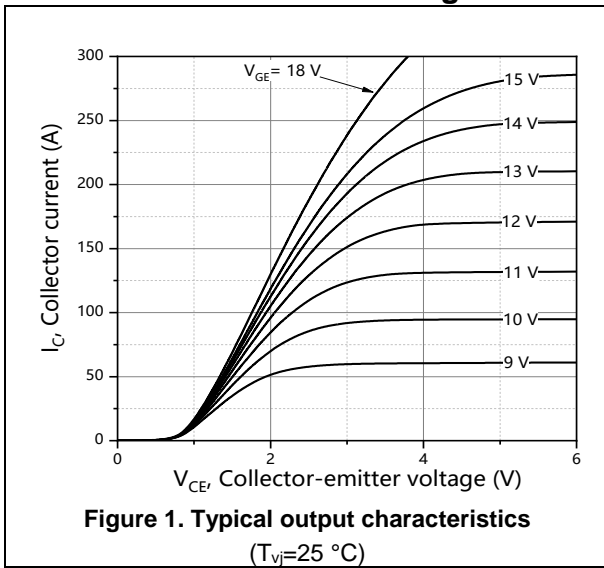

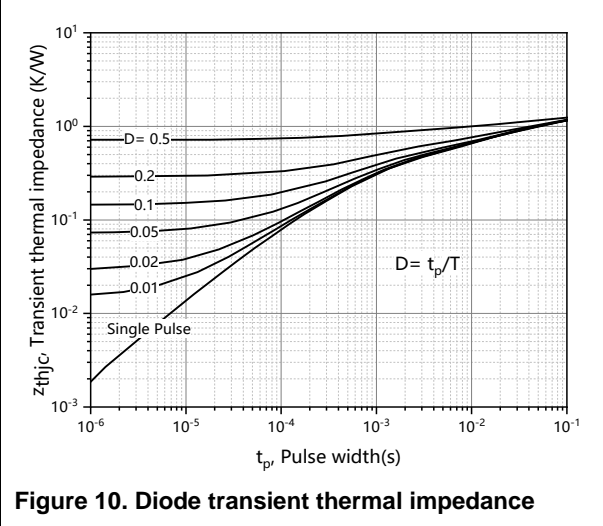
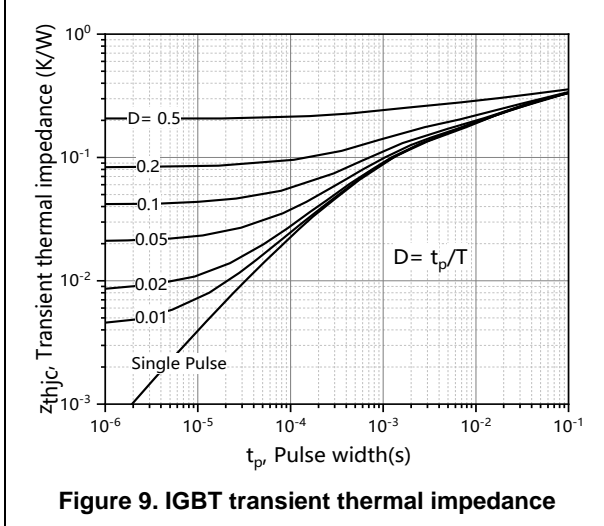
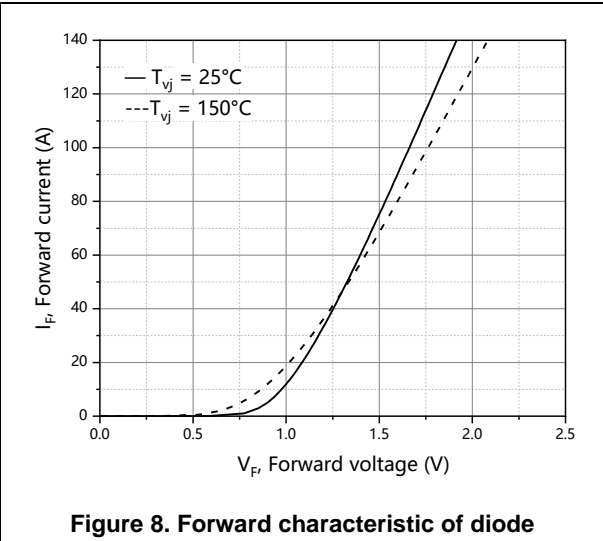
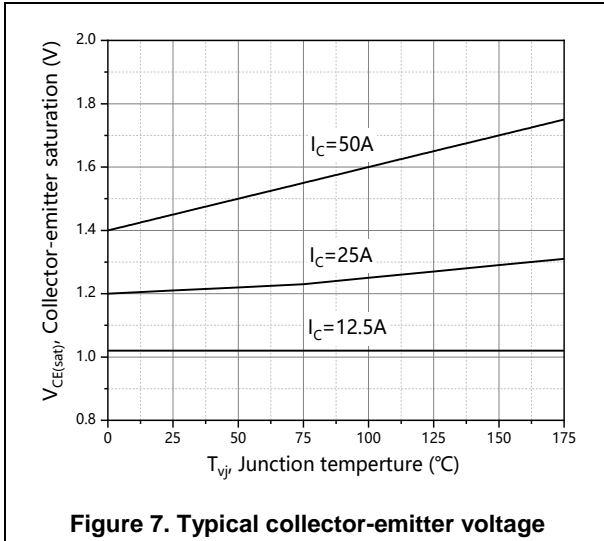

Package Information

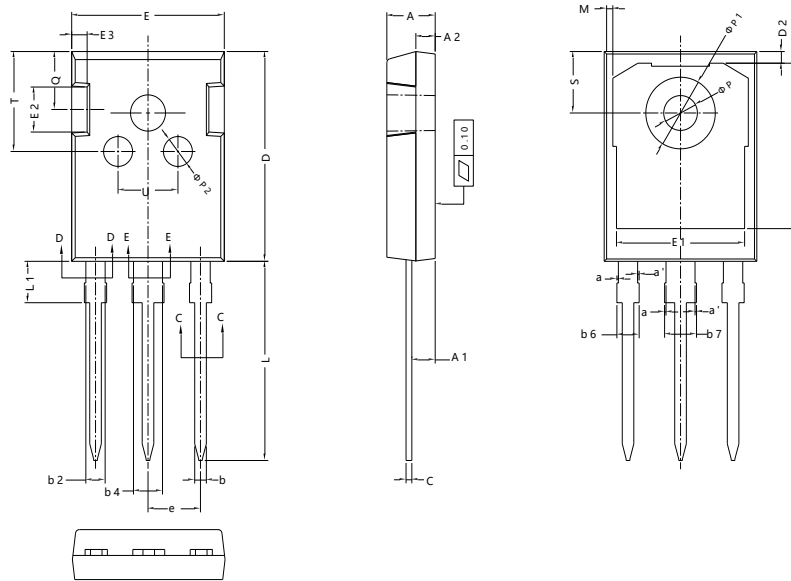

Symbol	mm		
	Min	Nom	Max
A	4.90	5.00	5.10
A1	2.31	2.41	2.51
A2	1.90	2.00	2.10
a	0.00	-	0.15
a'	0.00	-	0.15
b	1.16	-	1.26
b2	1.96	-	2.06
b4	2.96	-	3.06
b6	-	-	2.25
b7	-	-	3.25
c	0.59	-	0.66
c1	0.58	0.60	0.62
D	20.90	21.00	21.10
D1	16.25	16.55	16.85
D2	1.05	1.17	1.35
E	15.70	15.80	15.90
E1	13.10	13.30	13.50
E2	4.40	4.50	4.60
E3	1.50	1.60	1.70
e	5.436 BSC		
L	19.80	19.92	20.10
L1	-	-	4.30
M	0.35	-	0.95
P	3.40	3.50	3.60
P1	7.00	-	7.40
P2	2.40	2.5	2.6
Q	5.60	-	6.0
S	6.05	6.15	6.25
T	9.8	-	10.20
U	6.00	-	6.40

Version 1: TO247-J package outline dimension

Ordering Information

Package Type	Units/ Tube	Tubes/ Inner Box	Units/ Inner Box	Inner Boxes/ Carton Box	Units/ Carton Box
TO247-J	30	20	600	5	3000

Product Information

Product	Package	Pb Free	RoHS	Halogen Free
OST50N65HSZF	TO247	yes	yes	yes

Legal Disclaimer

The information given in this document shall in no event be regarded as a guarantee of conditions or characteristics. With respect to any examples or hints given herein, any typical values stated herein and/or any information regarding the application of the device, Oriental Semiconductor hereby disclaims any and all warranties and liabilities of any kind, including without limitation, warranties of non-infringement of intellectual property rights of any third party.

For further information on technology, delivery terms and conditions and prices, please contact the Oriental Semiconductor sales representatives (www.orientalsemi.com).

© Oriental Semiconductor Co.,Ltd. All Rights Reserved 