

100V N-Ch Power MOSFET

Feature

- ◇ Optimized for high speed smooth switching, Logic level
- ◇ Enhanced Body diode dv/dt capability
- ◇ Enhanced Avalanche Ruggedness
- ◇ 100% UIS Tested, 100% Rg Tested

Application

- ◇ DC-DC Conversion
- ◇ Hard Switching and High Speed Circuit
- ◇ Power Tools
- ◇ UPS
- ◇ SSR

V_{DS}		100	V
$R_{DS(on),typ}$	$V_{GS}=10V$	4.9	mΩ
$R_{DS(on),typ}$	$V_{GS}=4.5V$	5.8	mΩ
I_D		62.7	A

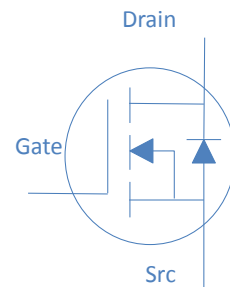

TO-220F



Part Number	Package	Marking
HGA055N10SL	TO-220F	GA055N10SL

Absolute Maximum Ratings at $T_j=25^\circ\text{C}$ (unless otherwise specified)

Parameter	Symbol	Conditions	Value	Unit
Continuous Drain Current	I_D	$T_C=25^\circ\text{C}$	63	A
		$T_C=100^\circ\text{C}$	44	
Drain to Source Voltage	V_{DS}	-	100	V
Gate to Source Voltage	V_{GS}	-	± 20	V
Pulsed Drain Current	I_{DM}	-	350	A
Avalanche Energy, Single Pulse	E_{AS}	$L=0.3\text{mH}, T_C=25^\circ\text{C}$	240	mJ
Power Dissipation	P_D	$T_C=25^\circ\text{C}$	43	W
Operating and Storage Temperature	T_J, T_{stg}	-	-55 to 175	$^\circ\text{C}$

Absolute Maximum Ratings

Parameter	Symbol	Max	Unit
Thermal Resistance Junction-Case	$R_{\theta JC}$	3.5	$^\circ\text{C/W}$
Thermal Resistance Junction-Ambient	$R_{\theta JA}$	50	$^\circ\text{C/W}$

Electrical Characteristics at $T_J=25^{\circ}\text{C}$ (unless otherwise specified)

Static Characteristics

Parameter	Symbol	Conditions	Value			Unit
			min	typ	max	
Drain to Source Breakdown Voltage	$V_{(BR)DSS}$	$V_{GS}=0V, I_D=250\mu A$	100	-	-	V
Gate Threshold Voltage	$V_{GS(th)}$	$V_{GS}=V_{DS}, I_D=250\mu A$	1.4	1.7	2.4	
Zero Gate Voltage Drain Current	I_{DSS}	$V_{GS}=0V, V_{DS}=100V, T_J=25^{\circ}\text{C}$	-	-	1	μA
		$V_{GS}=0V, V_{DS}=100V, T_J=100^{\circ}\text{C}$	-	-	100	
Gate to Source Leakage Current	I_{GSS}	$V_{GS}=\pm 20V, V_{DS}=0V$	-	-	± 100	nA
Drain to Source on Resistance	$R_{DS(on)}$	$V_{GS}=10V, I_D=20A$	-	4.9	5.5	$m\Omega$
		$V_{GS}=4.5V, I_D=20A$	-	5.8	7.3	$m\Omega$
Transconductance	g_{fs}	$V_{DS}=5V, I_D=20A$	-	70	-	S
Gate Resistance	R_G	$V_{GS}=0V, V_{DS}$ Open, $f=1\text{MHz}$	-	3.5	-	Ω

Dynamic Characteristics

Input Capacitance	C_{iss}	$V_{GS}=0V, V_{DS}=50V, f=1\text{MHz}$	-	4351	-	pF
Output Capacitance	C_{oss}		-	323	-	
Reverse Transfer Capacitance	C_{rss}		-	12	-	
Total Gate Charge	$Q_g(10V)$	$V_{DD}=50V, I_D=20A, V_{GS}=10V$	-	60	-	nC
Total Gate Charge	$Q_g(4.5V)$		-	26	-	
Gate to Source Charge	Q_{gs}		-	8	-	
Gate to Drain (Miller) Charge	Q_{gd}		-	10	-	
Turn on Delay Time	$t_{d(on)}$	$V_{DD}=50V, I_D=20A, V_{GS}=10V,$ $R_G=10\Omega,$	-	15	-	ns
Rise time	t_r		-	6	-	
Turn off Delay Time	$t_{d(off)}$		-	42	-	
Fall Time	t_f		-	8	-	

Reverse Diode Characteristics

Diode Forward Voltage	V_{SD}	$V_{GS}=0V, I_F=20A$	-	0.9	1.2	V
Reverse Recovery Time	t_{rr}	$V_R=50V, I_F=20A, di_F/dt=500A/\mu s$	-	50	-	ns
Reverse Recovery Charge	Q_{rr}		-	275	-	nC

Fig 1. Typical Output Characteristics

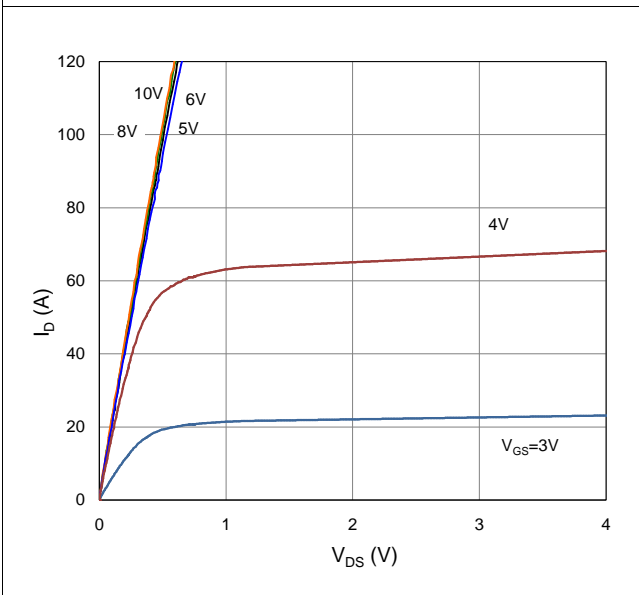

Figure 2. On-Resistance vs. Gate-Source Voltage

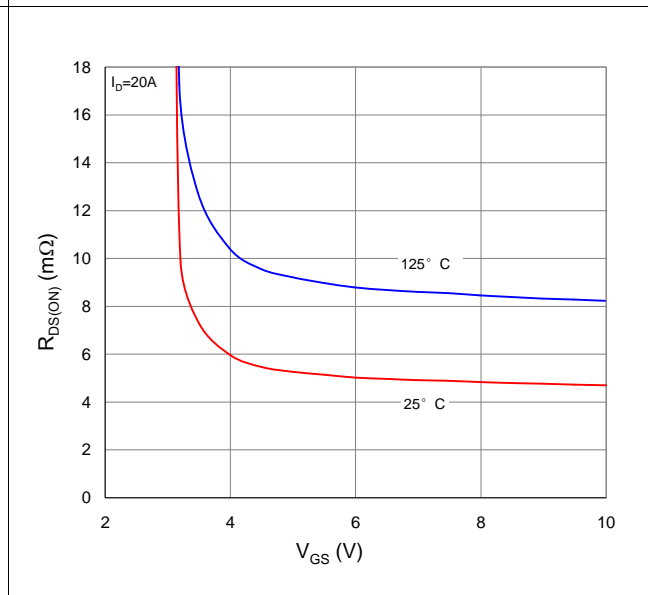

Figure 3. On-Resistance vs. Drain Current and Gate Voltage

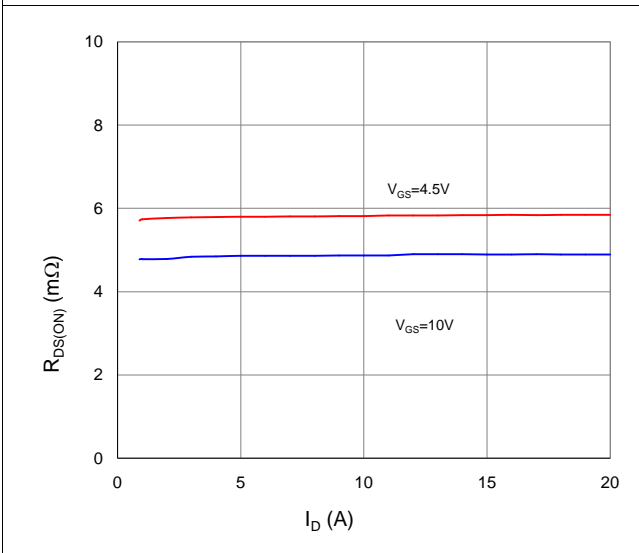

Figure 4. Normalized On-Resistance vs. Junction Temperature

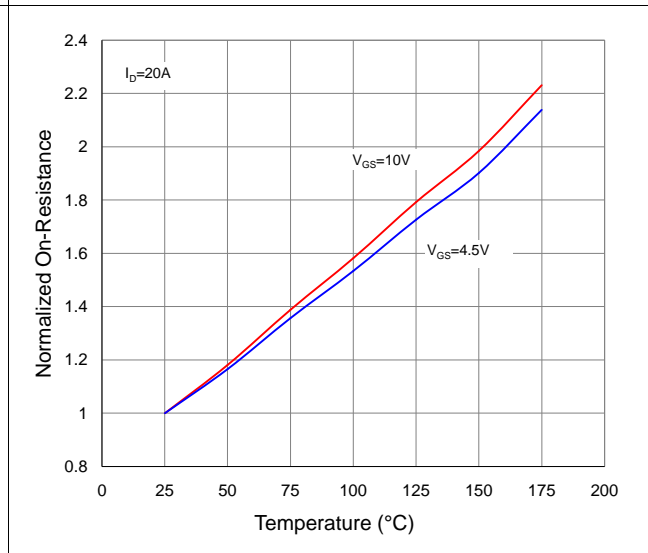

Figure 5. Typical Transfer Characteristics

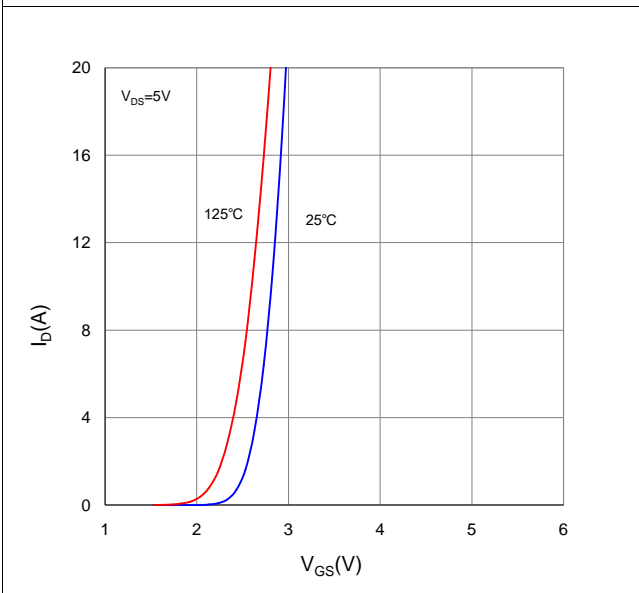

Figure 6. Typical Source-Drain Diode Forward Voltage

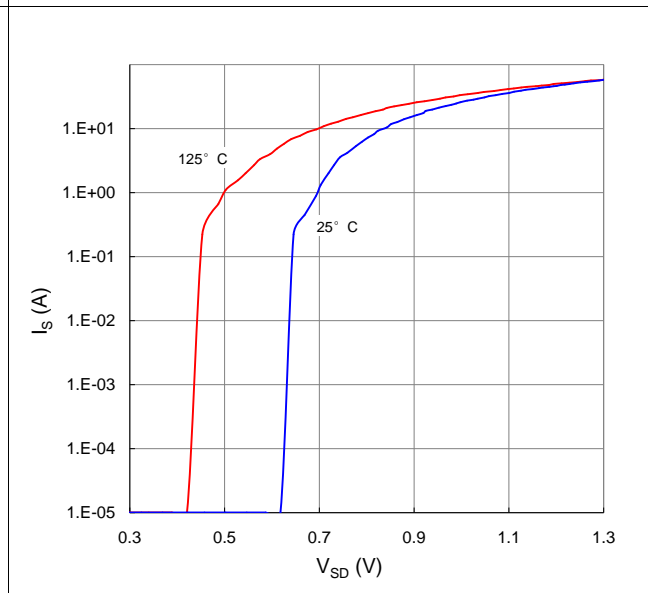

Figure 7. Typical Gate-Charge vs. Gate-to-Source Voltage

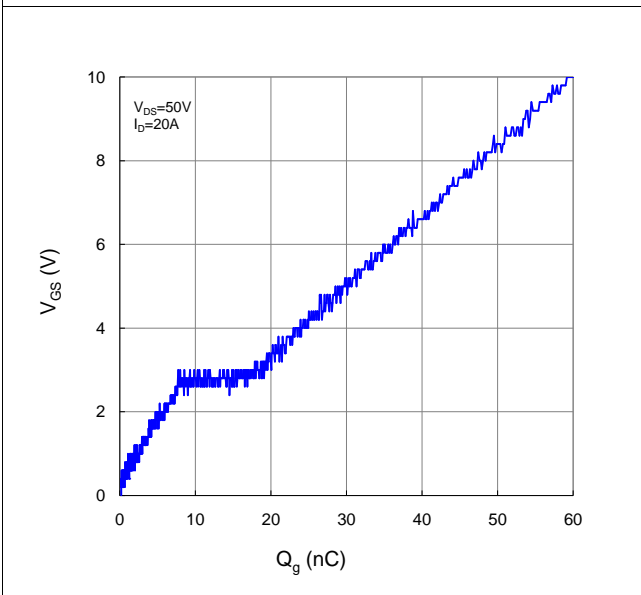

Figure 8. Typical Capacitance vs. Drain-to-Source Voltage

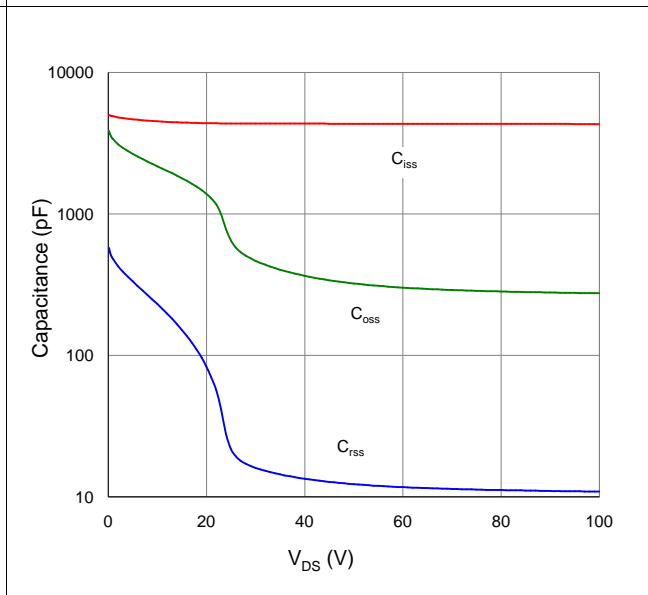

Figure 9. Maximum Safe Operating Area

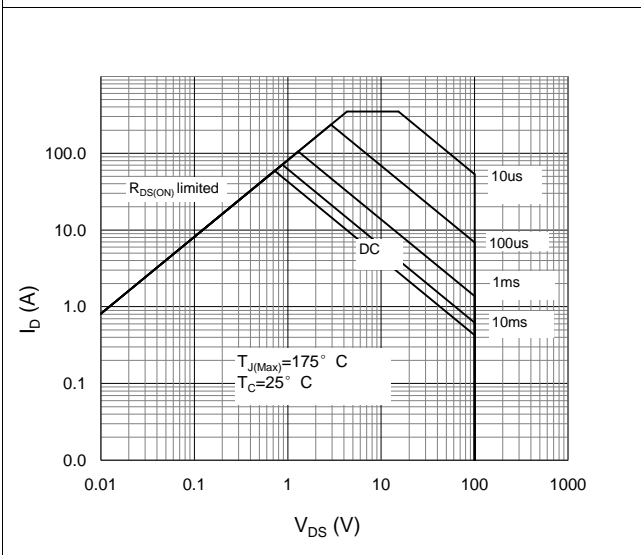

Figure 10. Maximum Drain Current vs. Case Temperature

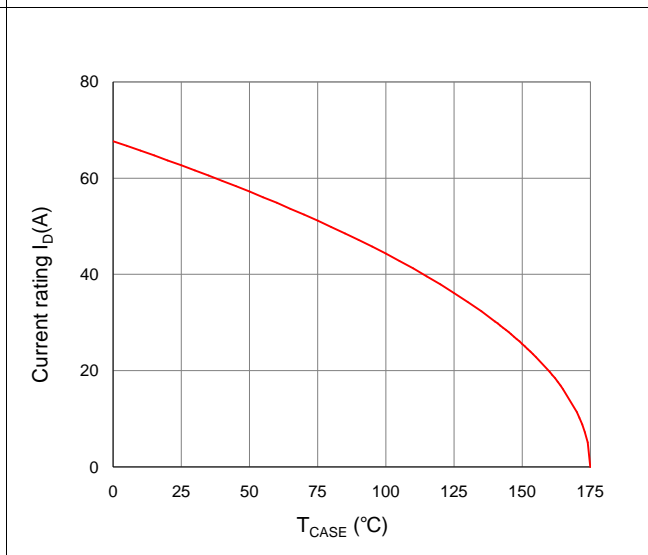
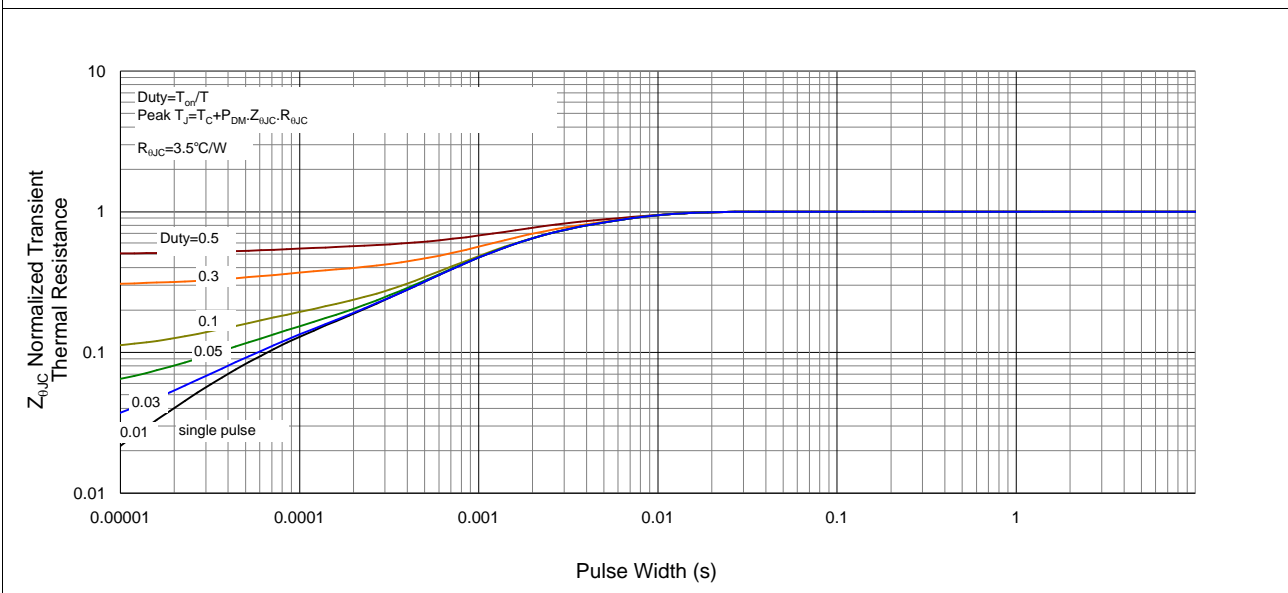
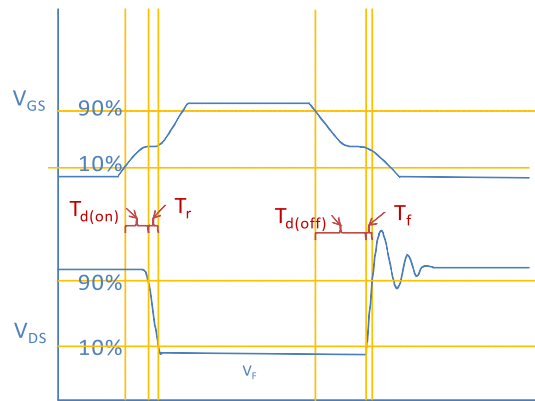
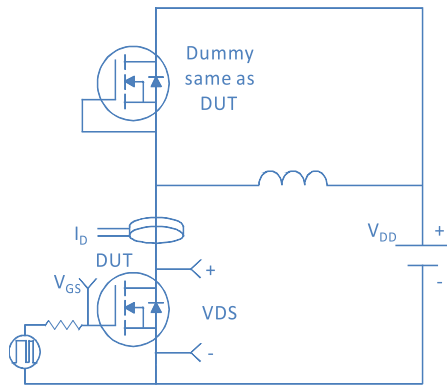

Figure 11. Normalized Maximum Transient Thermal Impedance, Junction-to-Case



Inductive switching Test



Gate Charge Test

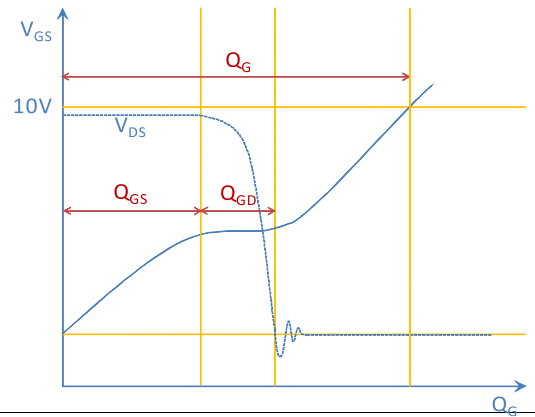

Uclamped Inductive Switching (UIS) Test



Diode Recovery Test

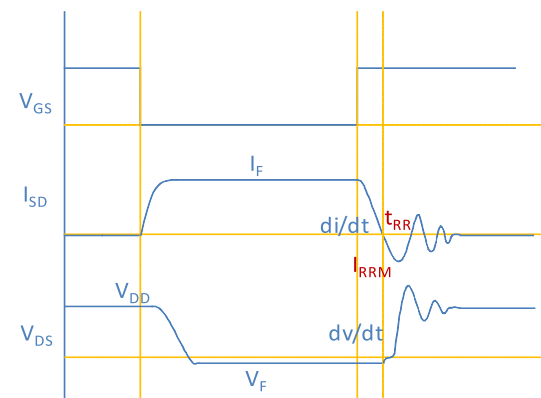

Package Outline

TO-220F, 3 leads

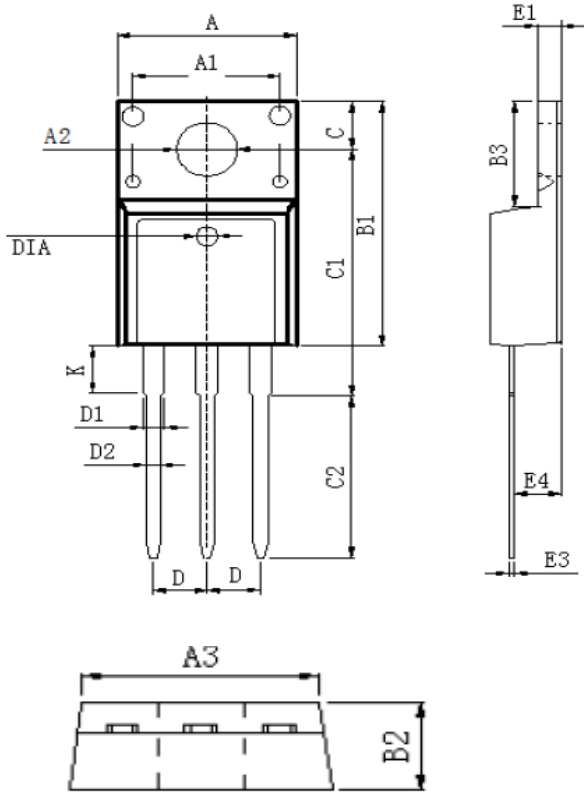

DIM	MILLIMETERS
A	10.16±0.3
A1	7.00±0.1
A2	3.3±0.2
A3	9.5±0.2
B1	15.87±0.3
B2	4.7±0.2
B3	6.68±0.4
C	3.3±0.2
C1	12.57±0.3
C2	10.02±0.5
D	2.54±0.05
D1	1.28±0.2
D2	0.8±0.1
K	3.1±0.3
E1	2.54±0.1
E3	0.5±0.1
E4	2.76±0.2
DIA	⊙1.5 (deep 0.2)

Unit :mm