

**100V N-Ch Power MOSFET**
**Feature**

- ◇ High Speed Power Switching, Logic Level
- ◇ Enhanced Body diode dv/dt capability
- ◇ Enhanced Avalanche Ruggedness
- ◇ 100% UIS Tested, 100% Rg Tested
- ◇ Lead Free, Halogen Free

$V_{DS}$		100	V
$R_{DS(on),typ}$	$V_{GS}=10V$	9.0	mΩ
$R_{DS(on),typ}$	$V_{GS}=4.5V$	11	mΩ
$I_D$ (Silicon Limited)		37.7	A

**Application**

- ◇ Synchronous Rectification in SMPS
- ◇ Hard Switching and High Speed Circuit
- ◇ DC/DC in Telecoms and Industrial

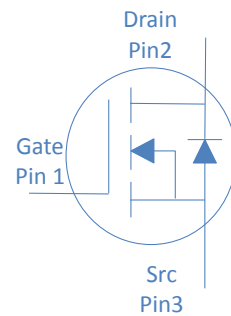
**TO-220F**

Part Number	Package	Marking
HGA110N10SL	TO-220F	GA110N10SL

**Absolute Maximum Ratings at  $T_j=25^\circ\text{C}$  (unless otherwise specified)**

Parameter	Symbol	Conditions	Value	Unit
Continuous Drain Current (Silicon Limited)	$I_D$	$T_C=25^\circ\text{C}$	38	A
		$T_C=100^\circ\text{C}$	27	
Drain to Source Voltage	$V_{DS}$	-	100	V
Gate to Source Voltage	$V_{GS}$	-	$\pm 20$	V
Pulsed Drain Current	$I_{DM}$	-	140	A
Avalanche Energy, Single Pulse	$E_{AS}$	$L=0.1\text{mH}, T_C=25^\circ\text{C}$	22	mJ
Power Dissipation	$P_D$	$T_C=25^\circ\text{C}$	33	W
Operating and Storage Temperature	$T_J, T_{stg}$	-	-55 to 175	$^\circ\text{C}$

**Absolute Maximum Ratings**

Parameter	Symbol	Max	Unit
Thermal Resistance Junction-Ambient	$R_{\theta JA}$	60	$^\circ\text{C/W}$
Thermal Resistance Junction-Case	$R_{\theta JC}$	4.5	$^\circ\text{C/W}$

**Electrical Characteristics at  $T_J=25^{\circ}\text{C}$  (unless otherwise specified)**
**Static Characteristics**

Parameter	Symbol	Conditions	Value			Unit
			min	typ	max	
Drain to Source Breakdown Voltage	$V_{(BR)DSS}$	$V_{GS}=0V, I_D=250\mu A$	100	-	-	V
Gate Threshold Voltage	$V_{GS(th)}$	$V_{GS}=V_{DS}, I_D=250\mu A$	1.4	1.9	2.4	
Zero Gate Voltage Drain Current	$I_{DSS}$	$V_{GS}=0V, V_{DS}=100V, T_J=25^{\circ}\text{C}$	-	-	1	$\mu A$
		$V_{GS}=0V, V_{DS}=100V, T_J=100^{\circ}\text{C}$	-	-	100	
Gate to Source Leakage Current	$I_{GSS}$	$V_{GS}=\pm 20V, V_{DS}=0V$	-	-	$\pm 100$	nA
Drain to Source on Resistance	$R_{DS(on)}$	$V_{GS}=10V, I_D=20A$	-	9	11	m $\Omega$
		$V_{GS}=4.5V, I_D=20A$	-	11	14	
Transconductance	$g_{fs}$	$V_{DS}=5V, I_D=20A$	-	60	-	S
Gate Resistance	$R_G$	$V_{GS}=0V, V_{DS}$ Open, $f=1\text{MHz}$	-	1.5	-	$\Omega$

**Dynamic Characteristics**

Input Capacitance	$C_{iss}$	$V_{GS}=0V, V_{DS}=50V, f=1\text{MHz}$	-	2275	-	pF
Output Capacitance	$C_{oss}$		-	162	-	
Reverse Transfer Capacitance	$C_{rss}$		-	7.9	-	
Total Gate Charge	$Q_g(10V)$	$V_{DD}=50V, I_D=14A, V_{GS}=10V$	-	29	-	nC
Total Gate Charge	$Q_g(4.5V)$		-	14	-	
Gate to Source Charge	$Q_{gs}$		-	5	-	
Gate to Drain (Miller) Charge	$Q_{gd}$		-	5	-	
Turn on Delay Time	$t_{d(on)}$	$V_{DD}=50V, I_D=14A, V_{GS}=10V,$ $R_G=10\Omega,$	-	8	-	ns
Rise time	$t_r$		-	3	-	
Turn off Delay Time	$t_{d(off)}$		-	26	-	
Fall Time	$t_f$		-	4	-	

**Reverse Diode Characteristics**

Diode Forward Voltage	$V_{SD}$	$V_{GS}=0V, I_F=20A$	-	0.9	1.2	V
Reverse Recovery Time	$t_{rr}$	$V_R=50V, I_F=12A, dI_F/dt=500A/\mu s$	-	33	-	ns
Reverse Recovery Charge	$Q_{rr}$		-	157	-	nC

Figure 1. Typical Output Characteristics

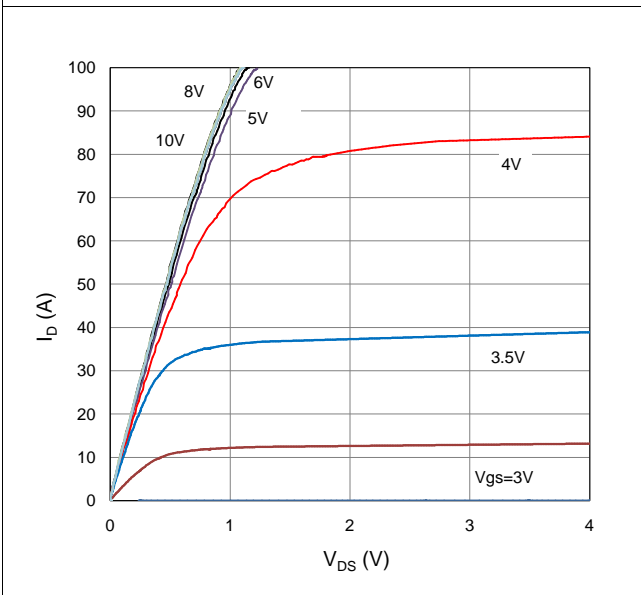

Figure 2. On-Resistance vs. Gate-Source Voltage

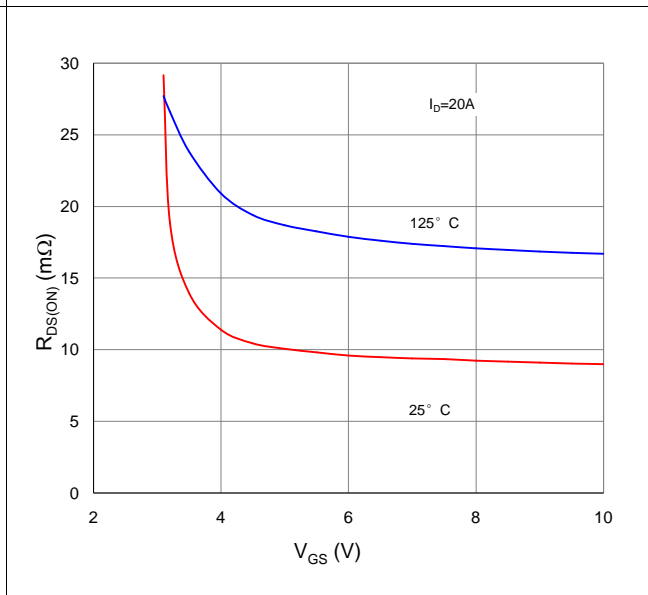

Figure 3. On-Resistance vs. Drain Current and Gate Voltage

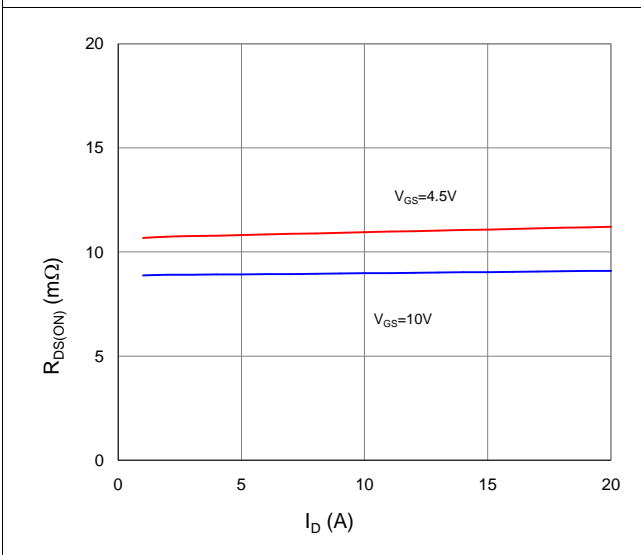

Figure 4. Normalized On-Resistance vs. Junction Temperature

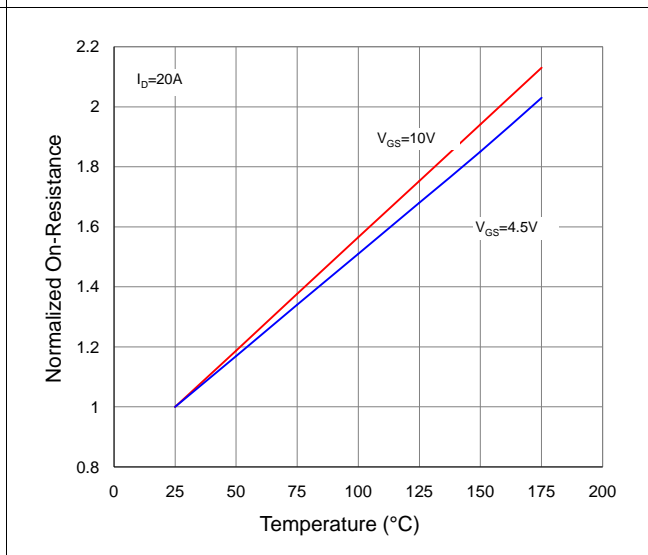

Figure 5. Typical Transfer Characteristics

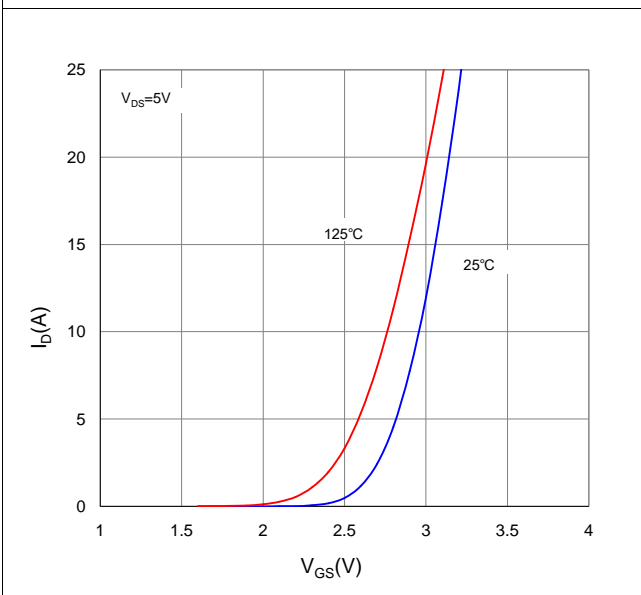

Figure 6. Typical Source-Drain Diode Forward Voltage

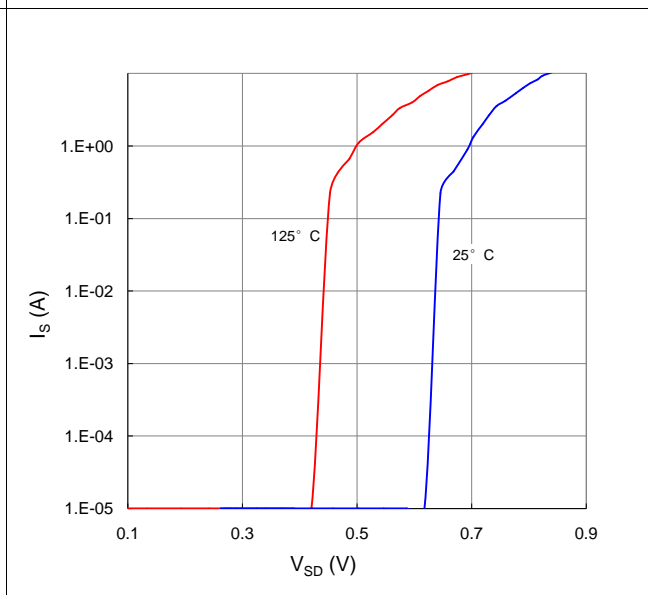

Figure 7. Typical Gate-Charge vs. Gate-to-Source Voltage

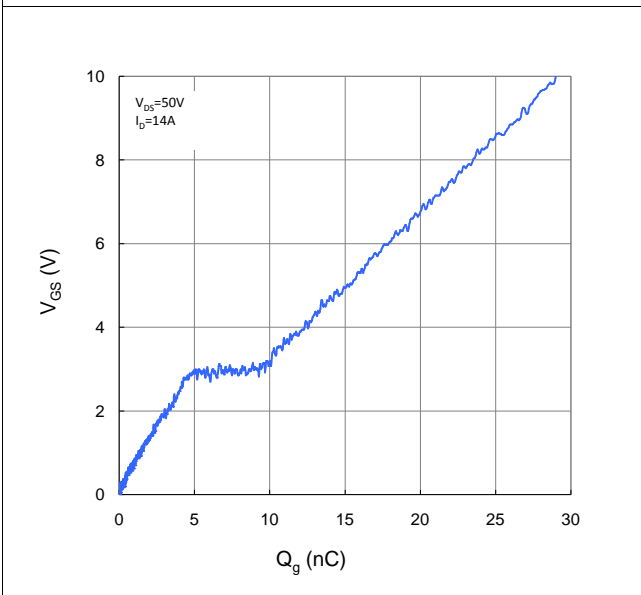

Figure 8. Typical Capacitance vs. Drain-to-Source Voltage

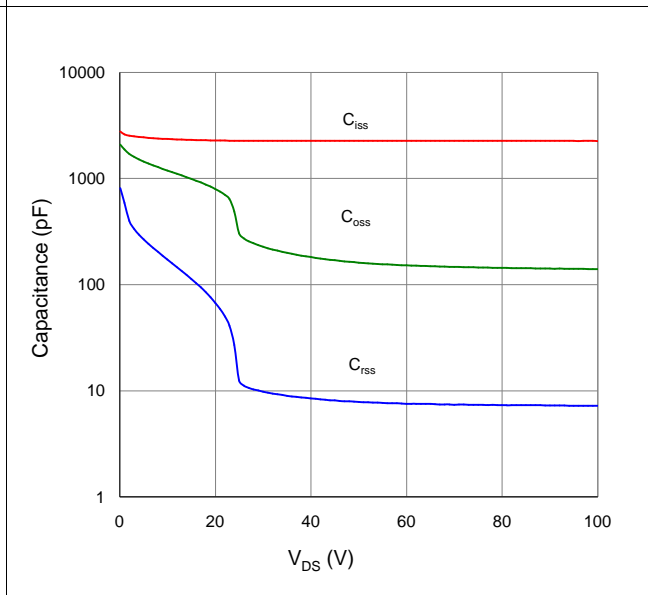

Figure 9. Maximum Safe Operating Area

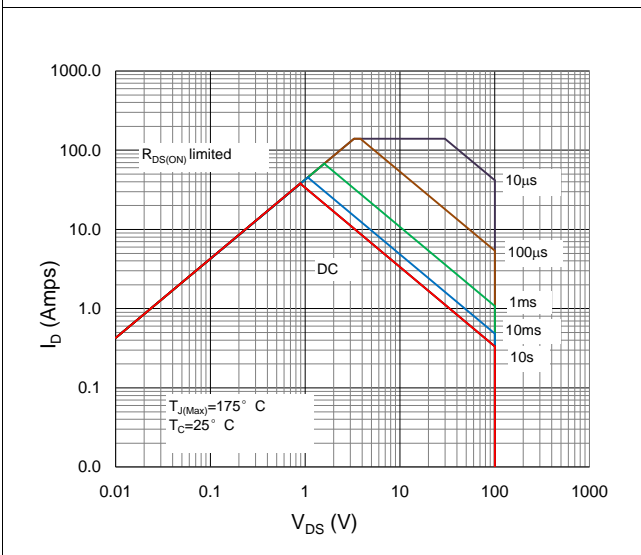

Figure 10. Maximum Drain Current vs. Case Temperature

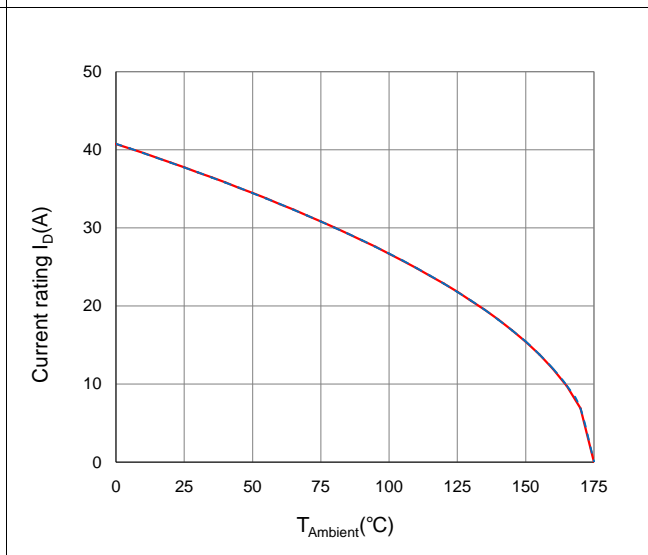
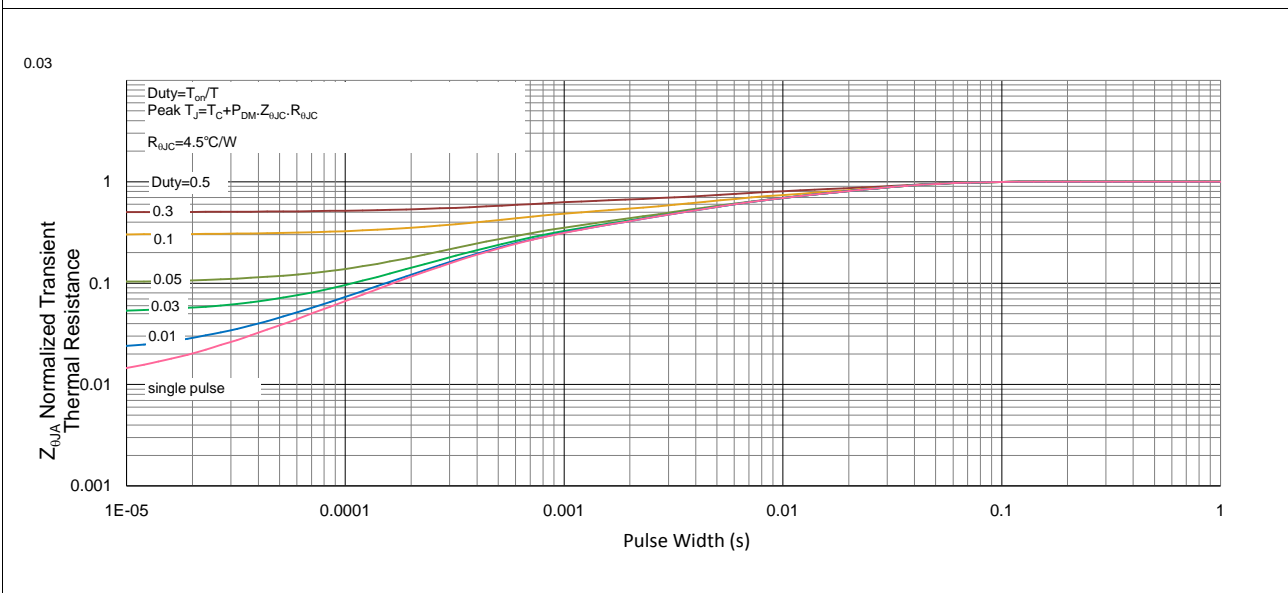
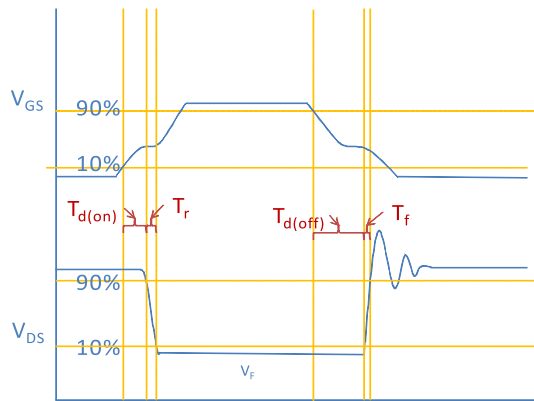

Figure 11. Normalized Maximum Transient Thermal Impedance, Junction-to-Ambient



Inductive switching Test



Gate Charge Test

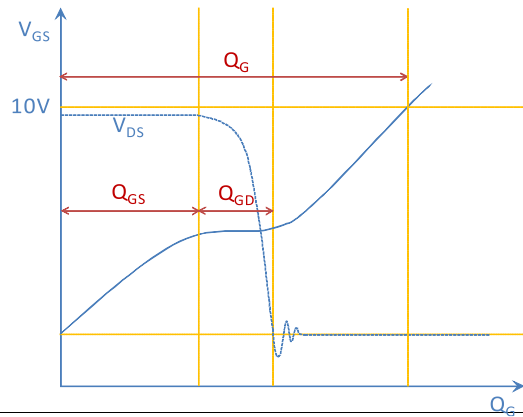

Uclamped Inductive Switching (UIS) Test

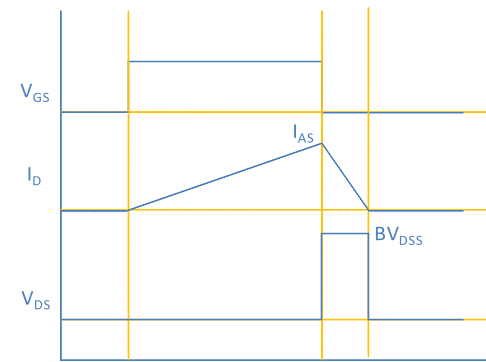

Diode Recovery Test

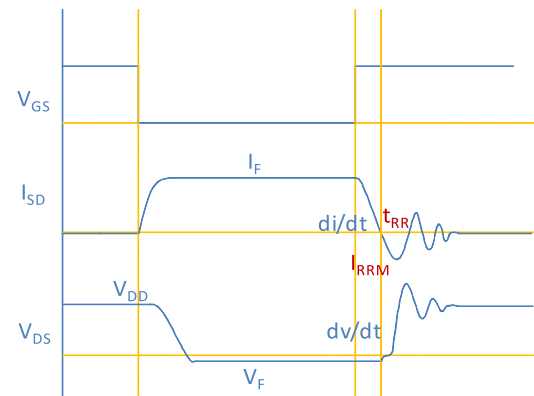
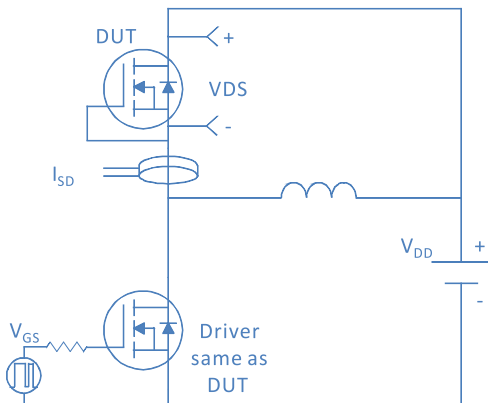

Package Outline

TO-220F, 3 leads

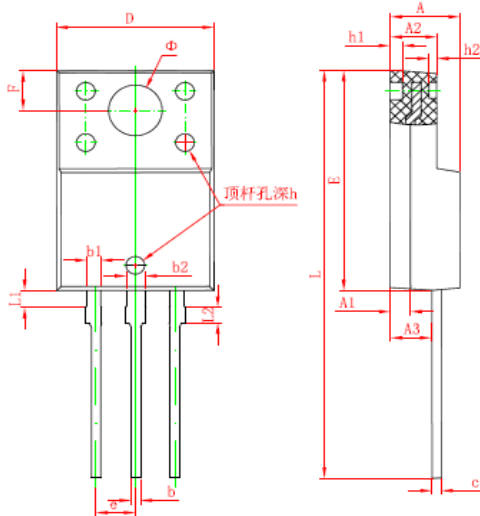

Symbol	Dimensions In Millimeters		Dimensions In Inches	
	Min.	Max.	Min.	Max.
A	4.350	4.650	0.169	0.185
A1	1.300 REF.		0.051 REF.	
A2	2.850	3.150	0.112	0.124
A3	2.600	2.800	0.102	0.110
b	0.500	0.750	0.020	0.030
b1	0.800	1.050	0.031	0.041
b2	1.100	1.350	0.043	0.053
c	0.500	0.750	0.020	0.030
D	9.960	10.360	0.392	0.408
E	14.800	15.200	0.583	0.598
e	2.540 TYP.		0.100 TYP.	
F	2.700 REF.		0.106 REF.	
φ	3.500 REF.		0.138 REF.	
h	0.000	0.300	0.000	0.012
h1	0.800 REF.		0.031 REF.	
h2	0.500 REF.		0.020 REF.	
L	28.000	28.400	1.102	1.118
L1	1.100	1.300	0.043	0.051
L2	0.920	1.080	0.036	0.043

