

150V N-Ch Power MOSFET
Feature

- ◇ High Speed Power Switching
- ◇ Enhanced Body diode dv/dt capability
- ◇ Enhanced Avalanche Ruggedness
- ◇ 100% UIS Tested, 100% Rg Tested
- ◇ Lead Free, Halogen Free

V_{DS}	150	V
$R_{DS(on),typ}$	2.35	m Ω
I_D (Silicon Limited)	366	A
I_D (Package Limited)	180	A

Application

- ◇ Synchronous Rectification in SMPS
- ◇ Hard Switching and High Speed Circuit
- ◇ DC/DC in Telecoms and Industrial

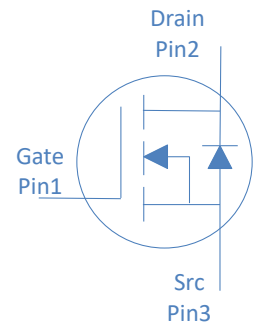

Part Number	Package	Marking
HGK026N15S	TO-247	GK026N15S

Absolute Maximum Ratings at $T_j=25^\circ\text{C}$ (unless otherwise specified)

Parameter	Symbol	Conditions	Value	Unit
Continuous Drain Current (Silicon Limited)	I_D	$T_C=25^\circ\text{C}$	366	A
		$T_C=100^\circ\text{C}$	258	
Continuous Drain Current (Package Limited)		$T_C=25^\circ\text{C}$	180	
Drain to Source Voltage	V_{DS}	-	150	V
Gate to Source Voltage	V_{GS}	-	± 20	V
Pulsed Drain Current	I_{DM}	-	1200	A
Avalanche Energy, Single Pulse	E_{AS}	$L=0.4\text{mH}, T_C=25^\circ\text{C}$	720	mJ
Power Dissipation	P_D	$T_C=25^\circ\text{C}$	833	W
Operating and Storage Temperature	T_J, T_{stg}	-	-55 to 175	$^\circ\text{C}$

Absolute Maximum Ratings

Parameter	Symbol	Max	Unit
Thermal Resistance Junction-Ambient	$R_{\theta JA}$	60	$^\circ\text{C/W}$
Thermal Resistance Junction-Case	$R_{\theta JC}$	0.18	$^\circ\text{C/W}$

Electrical Characteristics at $T_j=25^{\circ}\text{C}$ (unless otherwise specified)
Static Characteristics

Parameter	Symbol	Conditions	Value			Unit
			min	typ	max	
Drain to Source Breakdown Voltage	$V_{(BR)DSS}$	$V_{GS}=0V, I_D=250\mu A$	150	-	-	V
Gate Threshold Voltage	$V_{GS(th)}$	$V_{GS}=V_{DS}, I_D=250\mu A$	2.0	2.9	4.0	
Zero Gate Voltage Drain Current	I_{DSS}	$V_{GS}=0V, V_{DS}=150V, T_j=25^{\circ}\text{C}$	-	-	1	μA
		$V_{GS}=0V, V_{DS}=150V, T_j=100^{\circ}\text{C}$	-	-	100	
Gate to Source Leakage Current	I_{GSS}	$V_{GS}=\pm 20V, V_{DS}=0V$	-	-	± 100	nA
Drain to Source on Resistance	$R_{DS(on)}$	$V_{GS}=10V, I_D=20A$	-	2.35	2.8	$m\Omega$
Transconductance	g_{fs}	$V_{DS}=5V, I_D=20A$	-	80	-	S
Gate Resistance	R_G	$V_{GS}=0V, V_{DS}$ Open, $f=1\text{MHz}$	-	0.7	-	Ω

Dynamic Characteristics

Input Capacitance	C_{iss}	$V_{GS}=0V, V_{DS}=75V, f=1\text{MHz}$	-	11436	-	pF
Output Capacitance	C_{oss}		-	1431	-	
Reverse Transfer Capacitance	C_{rss}		-	16	-	
Total Gate Charge	$Q_g(10V)$	$V_{DD}=75V, I_D=20A, V_{GS}=10V$	-	138	-	nC
Gate to Source Charge	Q_{gs}		-	44	-	
Gate to Drain (Miller) Charge	Q_{gd}		-	20	-	
Turn on Delay Time	$t_{d(on)}$	$V_{DD}=75V, I_D=20A, V_{GS}=10V,$ $R_G=10\Omega,$	-	33	-	ns
Rise time	t_r		-	19	-	
Turn off Delay Time	$t_{d(off)}$		-	52	-	
Fall Time	t_f		-	24	-	

Reverse Diode Characteristics

Diode Forward Voltage	V_{SD}	$V_{GS}=0V, I_F=20A$	-	0.9	1.2	V
Reverse Recovery Time	t_{rr}	$V_R=75V, I_F=20A, di_F/dt=100A/\mu s$	-	150	-	ns
Reverse Recovery Charge	Q_{rr}		-	587	-	nC

Fig 1. Typical Output Characteristics

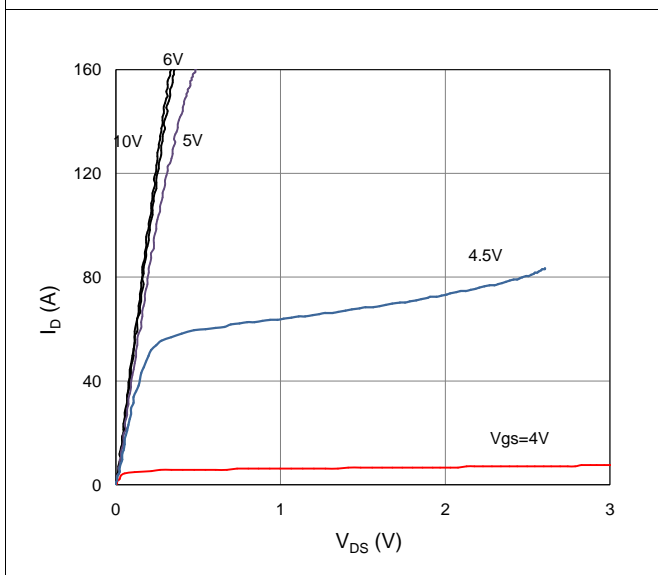

Figure 2. On-Resistance vs. Gate-Source Voltage

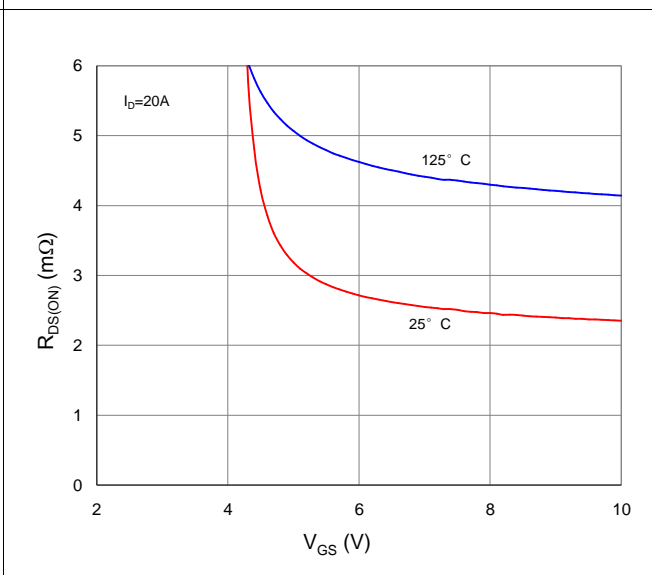

Figure 3. On-Resistance vs. Drain Current and Gate Voltage

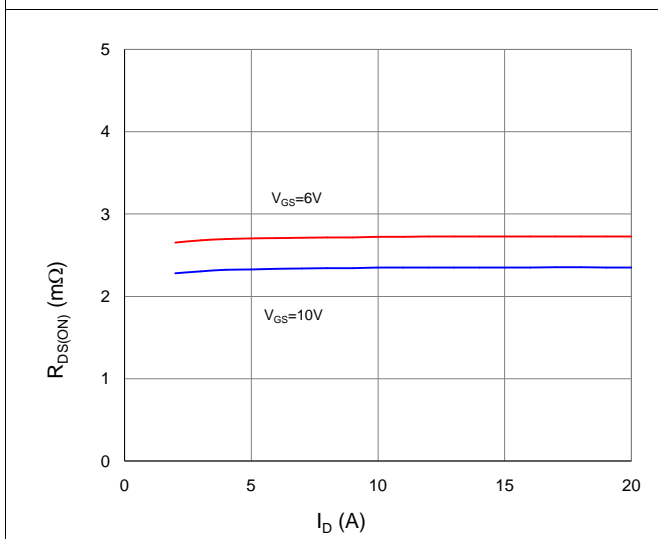

Figure 4. Normalized On-Resistance vs. Junction Temperature

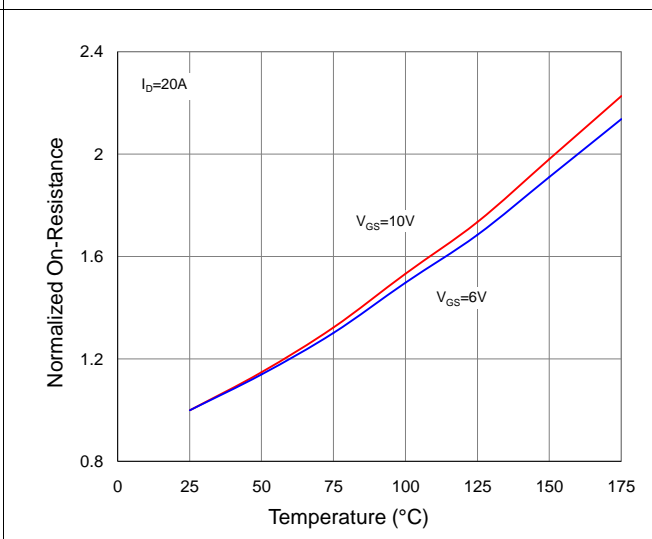

Figure 5. Typical Transfer Characteristics

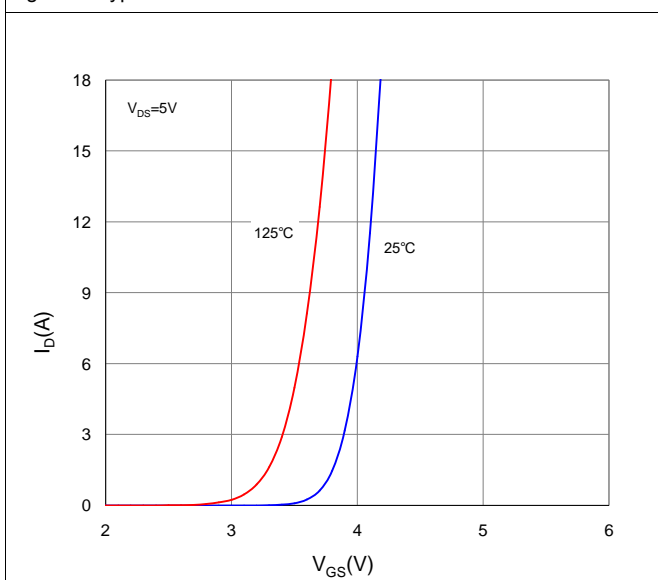

Figure 6. Typical Source-Drain Diode Forward Voltage

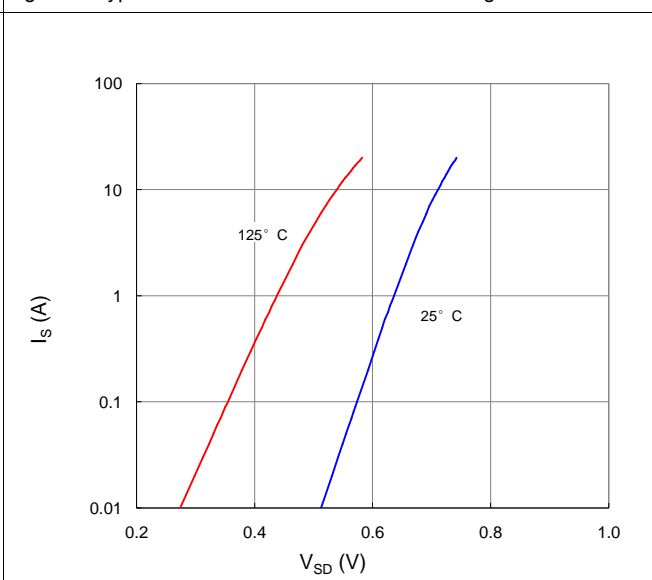

Figure 7. Typical Gate-Charge vs. Gate-to-Source Voltage

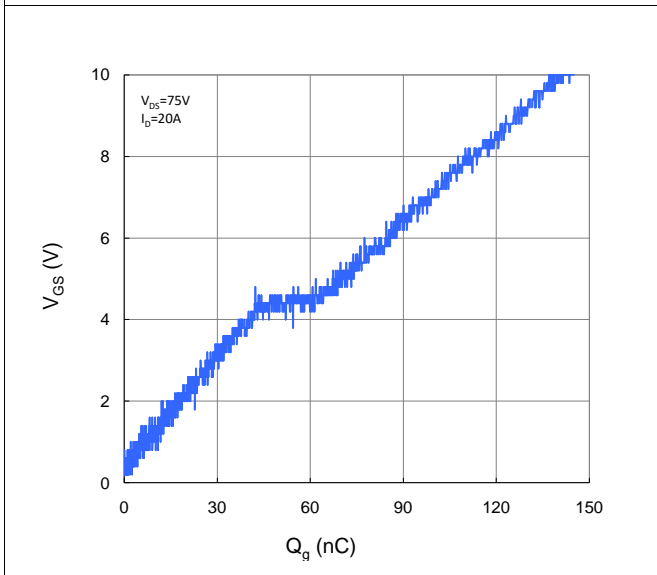

Figure 8. Typical Capacitance vs. Drain-to-Source Voltage

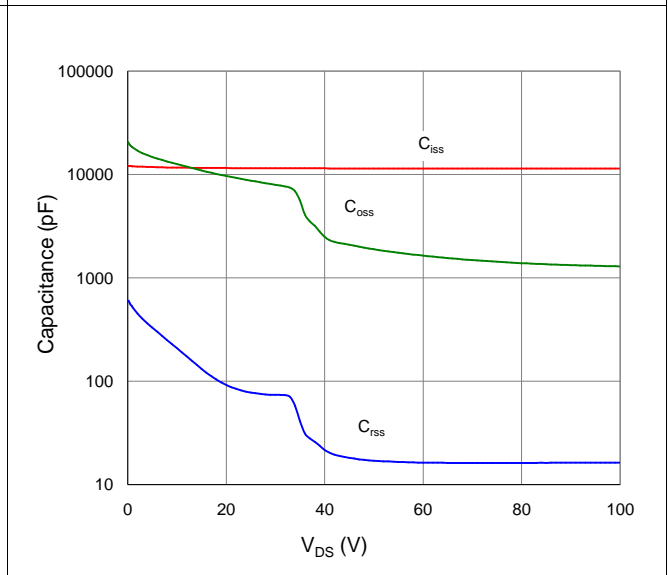

Figure 9. Maximum Safe Operating Area

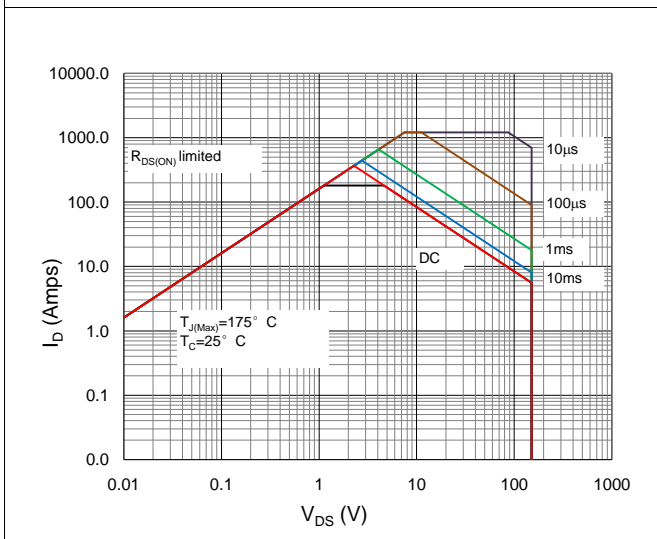

Figure 10. Maximum Drain Current vs. Case Temperature

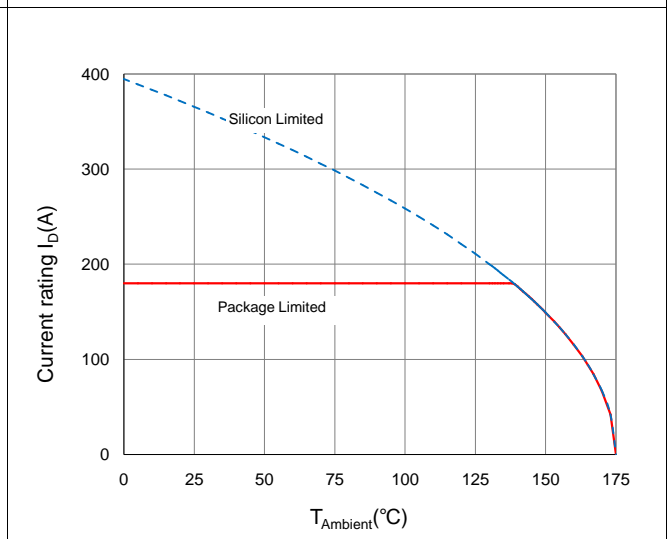
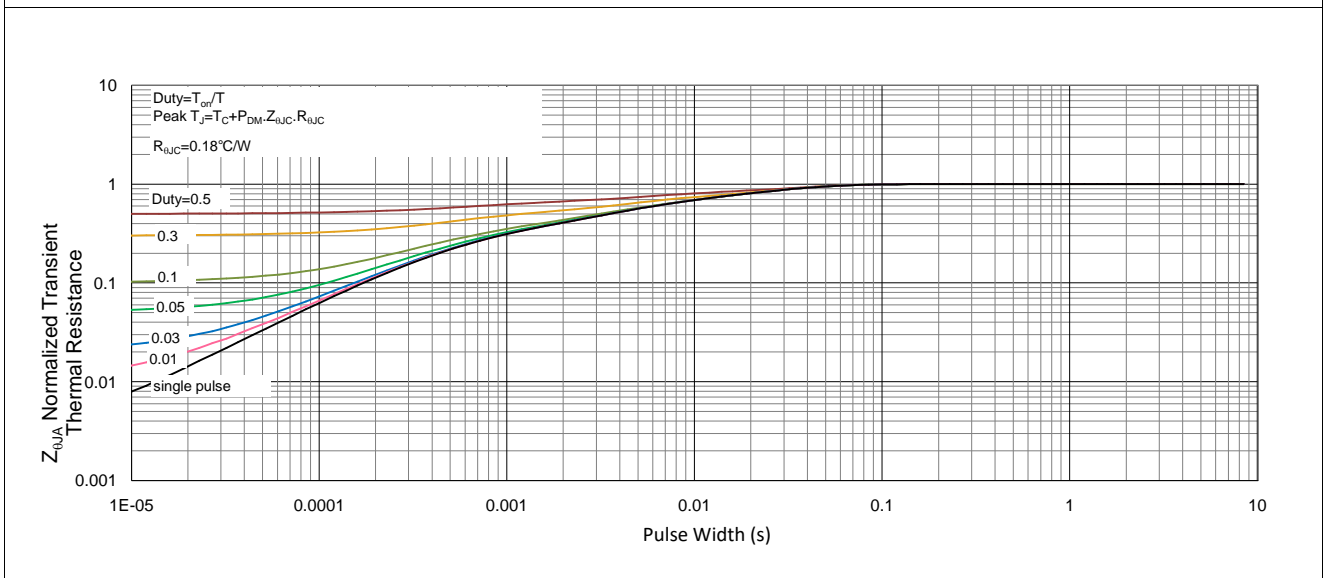
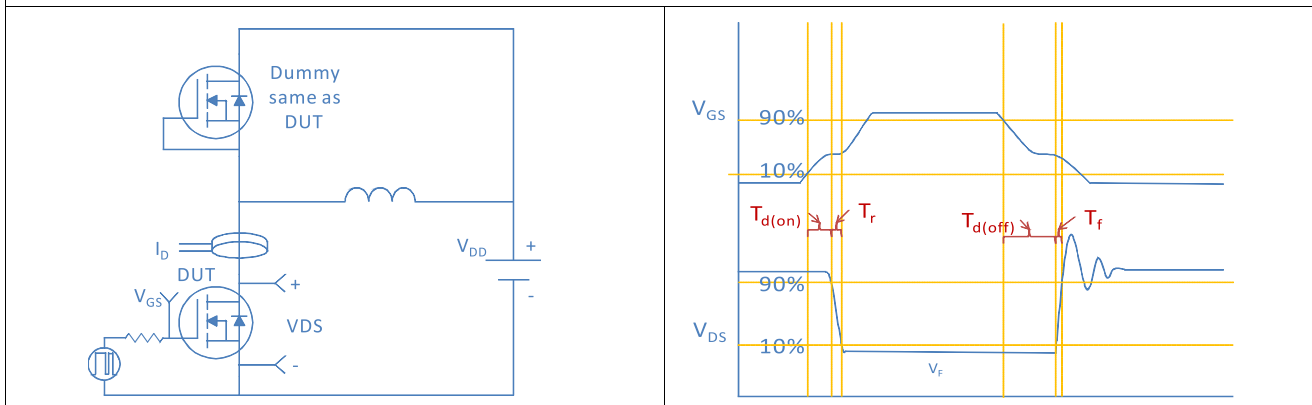

Figure 11. Normalized Maximum Transient Thermal Impedance, Junction-to-Ambient



Inductive switching Test



Gate Charge Test

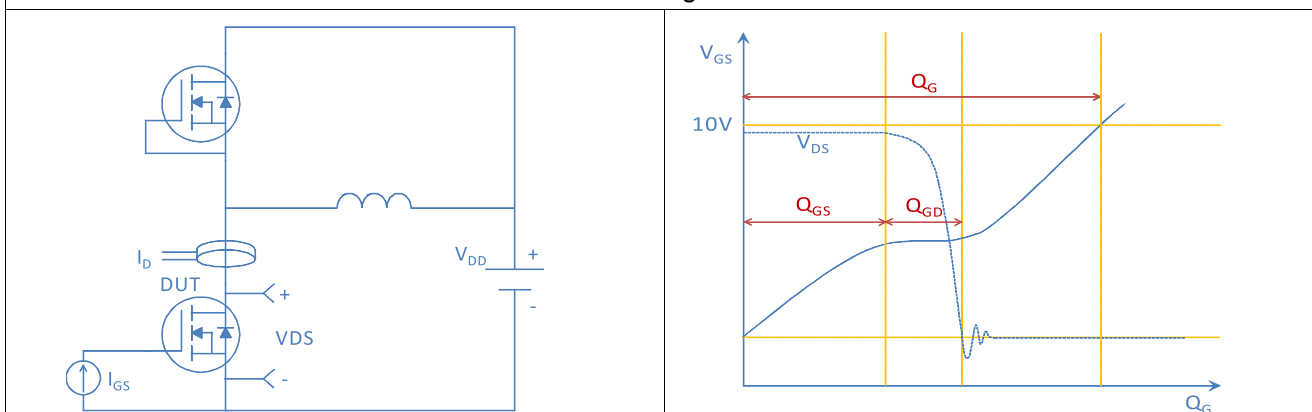

Unclamped Inductive Switching (UIS) Test

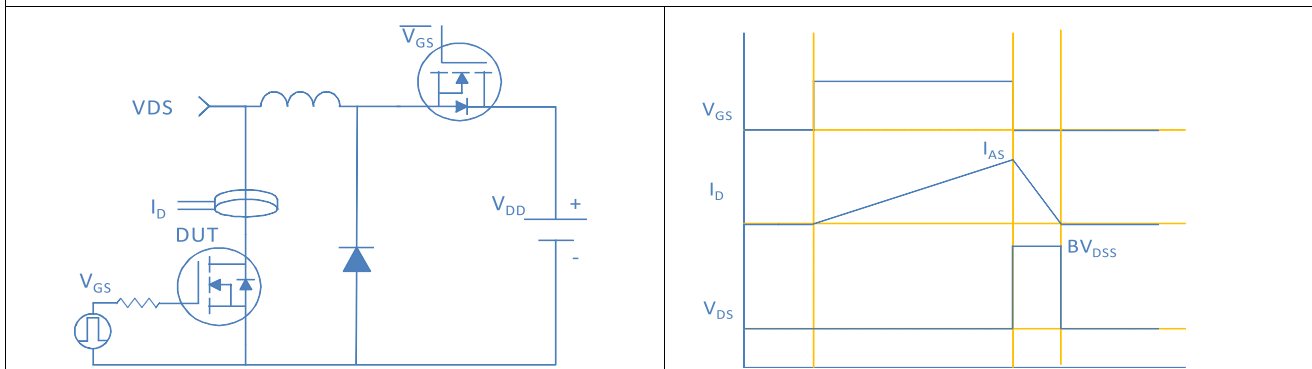

Diode Recovery Test

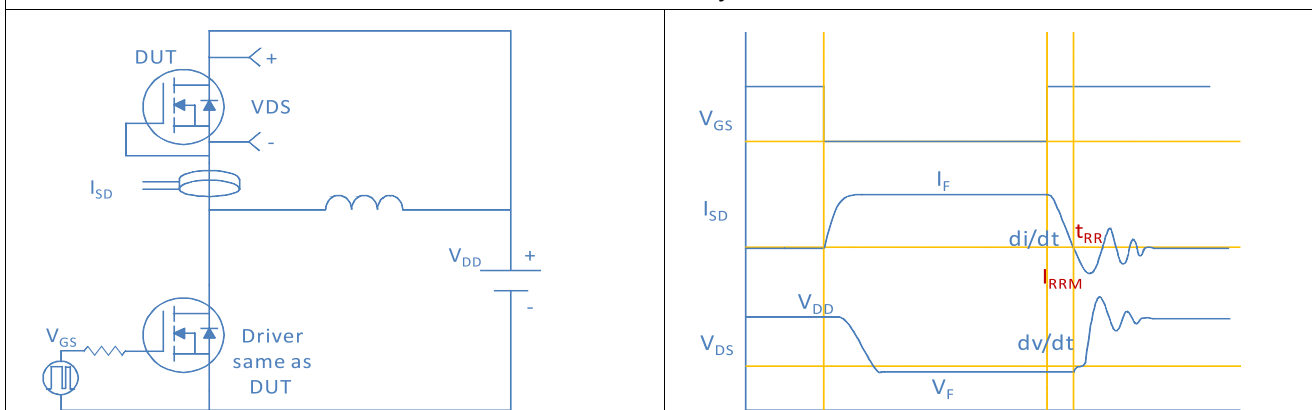

Package Outline

TO-247, 3 leads

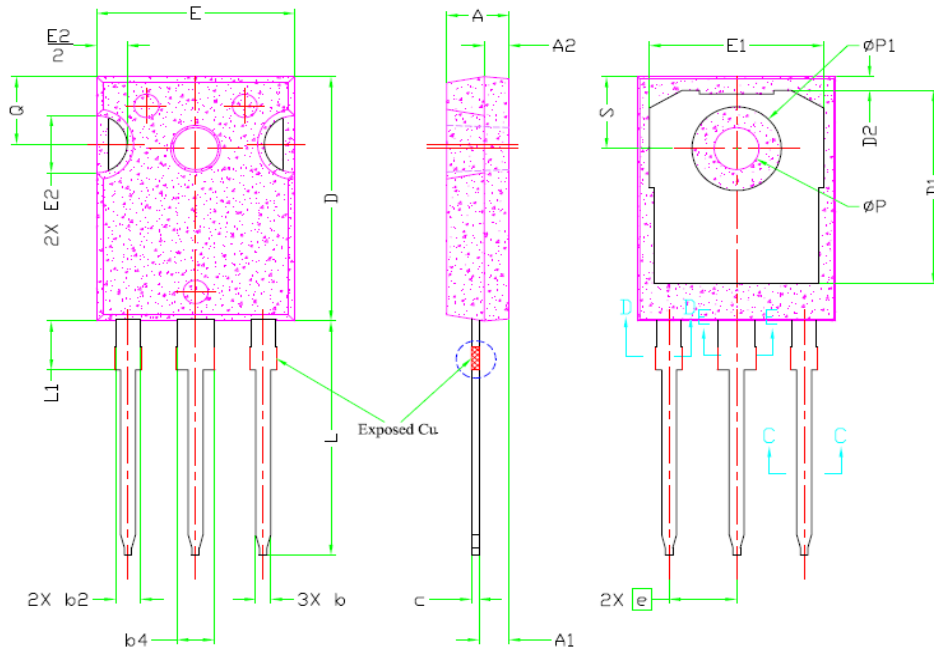

SYMBOL	DIMENSIONS			NOTES
	MIN.	NOM.	MAX.	
A	4.83	5.02	5.21	
A1	2.29	2.41	2.55	
A2	1.50	2.00	2.49	
b	1.12	1.20	1.33	
b1	1.12	1.20	1.28	
b2	1.91	2.00	2.39	6
b3	1.91	2.00	2.34	
b4	2.87	3.00	3.22	6, 8
b5	2.87	3.00	3.18	
c	0.55	0.60	0.69	6
c1	0.55	0.60	0.65	
D	20.80	20.95	21.10	4
D1	16.25	16.55	17.65	5
D2	0.51	1.19	1.35	
E	15.75	15.94	16.13	4
E1	13.46	14.02	14.16	5
E2	4.32	4.91	5.49	3
e	5.44BSC			
L	19.81	20.07	20.32	
L1	4.10	4.19	4.40	6
$\varnothing P$	3.56	3.61	3.65	7
$\varnothing P1$	7.19REF.			
Q	5.39	5.79	6.20	
S	6.04	6.17	6.30	