

JHH75N120HA

Product Preview

**1200V/75A HIGH SPEED FIELD-STOP TRENCH IGBT
WITH DIODE**

Features

- High Speed Switching
- Low $V_{CE(sat)}$
- High Ruggedness



Product Summary	
V_{CES}	1200V
I_C	75A ⁽¹⁾
$V_{CE(sat),typ}$	1.75V ($T_J = 25^\circ\text{C}$)
Package	TO-247

Applications

- High Frequency Converters
- Uninterrupted Power Supply
- Solar Inverters
- Welding

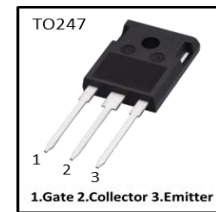
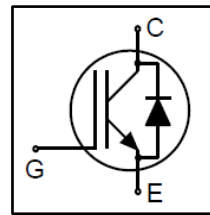
Ordering Information

Part Number	Marking	Package	Packing
JHH75N120HA	HH75N120HA	TO-247	Tube

Absolute Maximum Ratings

Parameter	Symbol	Limit	Unit
Collector-to-Emitter Voltage	V_{CES}	1200	V
Gate-to-Emitter Voltage	V_{GES}	± 20	
DC Collector Current ($T_c = 25^\circ\text{C}$, $T_J = 175^\circ\text{C}$)	I_C	109	A
DC Collector Current ($T_c = 90^\circ\text{C}$, $T_J = 175^\circ\text{C}$)		75	
Pulsed Collector Current (pulse width limited by maximum T_J)	I_{CM}	225	
Diode Forward Current ($T_c = 25^\circ\text{C}$, $T_J = 175^\circ\text{C}$)	I_F	114	
Diode Forward Current ($T_c = 90^\circ\text{C}$, $T_J = 175^\circ\text{C}$)		75	
Diode Pulsed Current (pulse width limited by maximum T_J)	I_{FM}	225	
Turn-off Safe Operating Area ($V_{CE} \leq 1200\text{V}$, $T_J \leq 175^\circ\text{C}$)	-	225	A
Maximum Power Dissipation ($T_c = 25^\circ\text{C}$, $T_J = 175^\circ\text{C}$)	$P_{D(max)}$	441	W
Operating Junction Temperature	T_J	-40 to +175	°C
Storage Temperature	T_{stg}	-55 to +150	
Maximum Lead Temperature for Soldering (1/8" from case for 5 seconds)	T_{slid}	260	

Static Electrical Characteristics ⁽²⁾

Parameter	Symbol	Test Conditions	Min	Typ	Max	Unit
Collector-to-Emitter Breakdown Voltage	BV_{CES}	$V_{GE} = 0V, I_C = 250\mu A$	1200	-	-	V
Collector-to-Emitter Leakage Current	I_{CES}	$V_{CE} = 1200V, V_{GE} = 0V$	-	-	10	μA
		$V_{CE} = 1200V, V_{GE} = 0V,$ $T_J = 150^\circ C$	-	-	5	mA
		$V_{CE} = 1200V, V_{GE} = 0V,$ $T_J = 175^\circ C$	-	-	20	mA
Gate-to-Emitter Leakage Current	I_{GES}	$V_{CE} = 0V, V_{GE} = \pm 20V$	-	-	100	nA
Gate Threshold Voltage	$V_{GE(th)}$	$V_{CE} = V_{GE}, I_C = 1.5mA$	4.3	5.5	6.7	V
Collector-to-Emitter Saturation Voltage	$V_{CE(sat)}$	$V_{GE} = 15V, I_C = 75A$	-	1.75	2.1	
		$V_{GE} = 15V, I_C = 75A,$ $T_J = 150^\circ C$	-	2.55	-	
		$V_{GE} = 15V, I_C = 75A,$ $T_J = 175^\circ C$	-	2.8	-	
Diode Forward Voltage	V_F	$V_{GE} = 0V, I_F = 75A$	-	2	2.4	
		$V_{GE} = 0V, I_F = 75A$ $T_J = 150^\circ C$	-	1.8	-	
		$V_{GE} = 0V, I_F = 75A$ $T_J = 175^\circ C$	-	1.7	-	

Thermal Characteristics

Parameter	Symbol	Min	Typ	Max	Unit
Junction-to-Ambient Thermal Resistance	$R_{\theta JA}$	-	-	40	$^\circ C/W$
Junction-to-Case Thermal Resistance, IGBT	$R_{\theta JC}$	-	-	0.34	
Junction-to-Case Thermal Resistance, Diode		-	-	0.54	

Dynamic Electrical Characteristics ⁽²⁾

Parameter	Symbol	Test Conditions	Min	Typ	Max	Unit
Total Gate Charge	Q_g	$V_{CC} = 600V,$ $V_{GE} = 15V,$ $I_C = 75A$	-	242	-	nC
Input Capacitance	C_{iss}	$V_{CE} = 25V,$ $V_{GE} = 0V,$ $f = 1MHz$	-	5195	-	pF
Output Capacitance	C_{oss}		-	183	-	
Reverse Transfer Capacitance	C_{rss}		-	51	-	

Switching Characteristics, Inductive Load (2), (3)

Parameter	Symbol	Test Conditions	Min	Typ	Max	Unit
Turn-on Delay time	$t_{d(ON)}$	$V_{CC} = 600V,$ $V_{GE} = 0/15V,$ $R_G = 10\Omega,$ $I_C = 75A,$ $L_{load} = 0.82mH,$ Energy losses include "tail" and diode reverse recovery.	-	56	-	ns
Rise Time	t_r		-	78	-	
Turn-off Delay time	$t_{d(OFF)}$		-	239	-	
Fall Time	t_f		-	57	-	
Turn-On Switching Loss	E_{on}		-	4.5	-	mJ
Turn-Off Switching Loss	E_{off}		-	2.2	-	
IGBT Total Switching Loss	E_{ts}		-	6.7	-	
Diode Reverse-Recovery Time	t_{rr}	$V_R = 600V,$ $I_F = 75A,$ $di_F/dt = 770A/\mu s$	-	197	-	ns
Diode Reverse-Recovery Charge	Q_{rr}		-	2780	-	nC
Diode Peak Reverse-Recovery Current	I_{rrm}		-	26	-	A

(1) DC collector current, $T_c = 90C$, $T_J = 175^\circ C$.

(2) $T_J = 25^\circ C$ unless otherwise specified

(3) t_r : from 10% of I_C to 90% of I_C ; t_f : from 90% of I_C to 10% of I_C ;

E_{on} : from 10% of V_{GE} to 10% of V_{CE} ; E_{off} : from 90% of V_{GE} to 10% of I_C .

Typical Electrical Characteristics

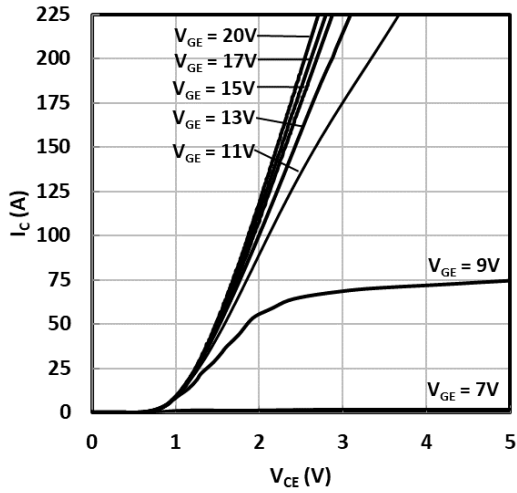

Fig. 1 Typical output characteristics
($T_J = 25\text{ }^\circ\text{C}$, $t_p = 250\text{ }\mu\text{s}$)

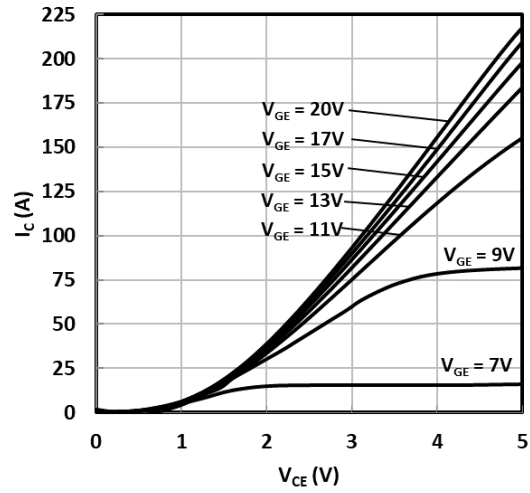

Fig. 2 Typical output characteristics
($T_J = 175\text{ }^\circ\text{C}$, $t_p = 250\text{ }\mu\text{s}$)

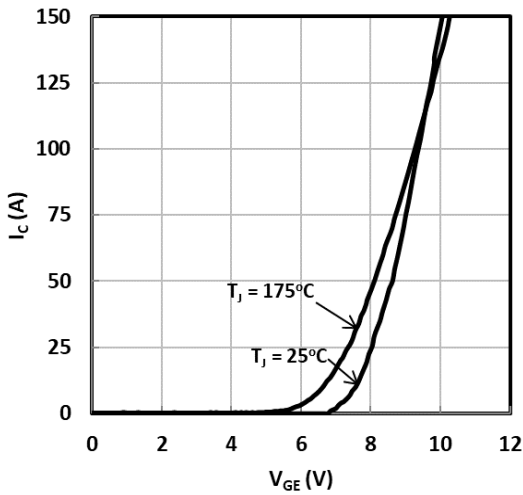

Fig. 3 Typical transfer characteristics
($V_{CE} = 20\text{ V}$, $t_p = 250\text{ }\mu\text{s}$)

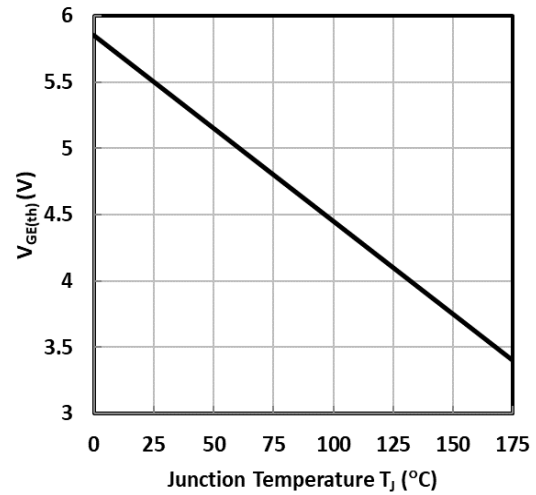

Fig. 4 Typical gate threshold voltage as a function of junction temperature
($V_{CE} = V_{GE}$, $I_C = 1.5\text{ mA}$)

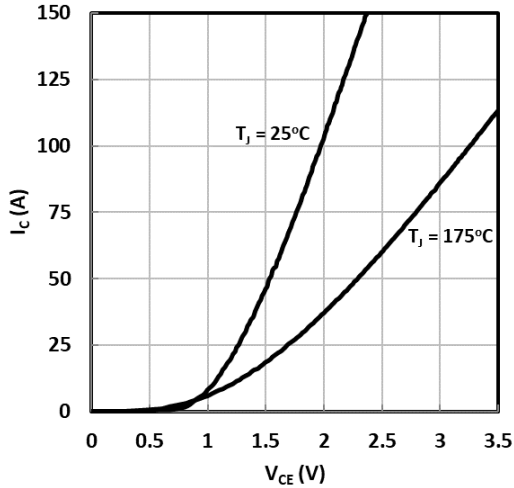

Fig. 5 Typical saturation voltage characteristics
($V_{GE} = 15\text{ V}$, $t_p = 250\ \mu\text{s}$)

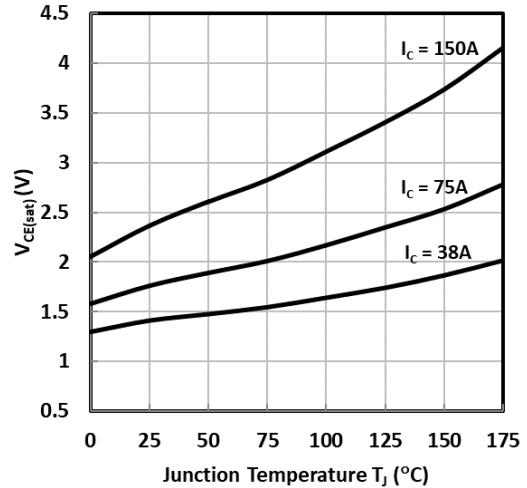

Fig. 6 Typical saturation voltage as a function of junction temperature
($V_{GE} = 15\text{ V}$, $t_p = 250\ \mu\text{s}$)

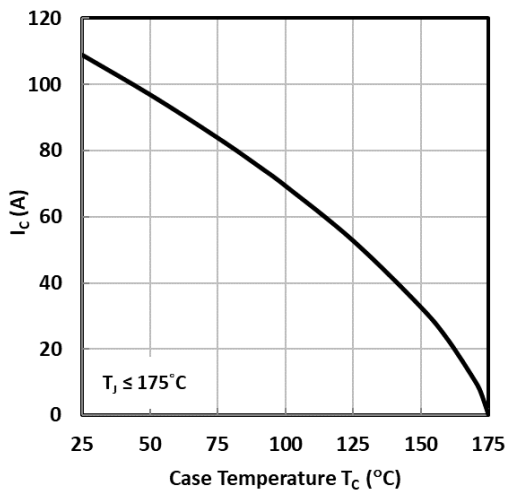

Fig. 7 Maximum DC collector current as a function of case temperature

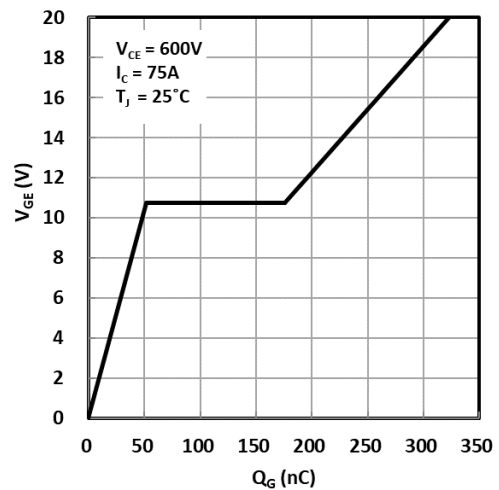

Fig. 8 Typical gate charge characteristics

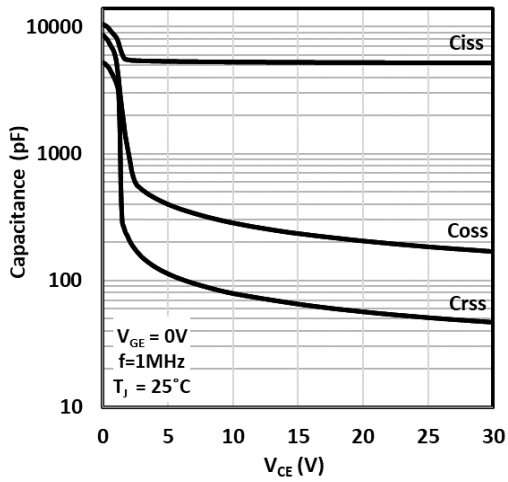

Fig. 9 Typical capacitance as a function of collector-to-emitter voltage

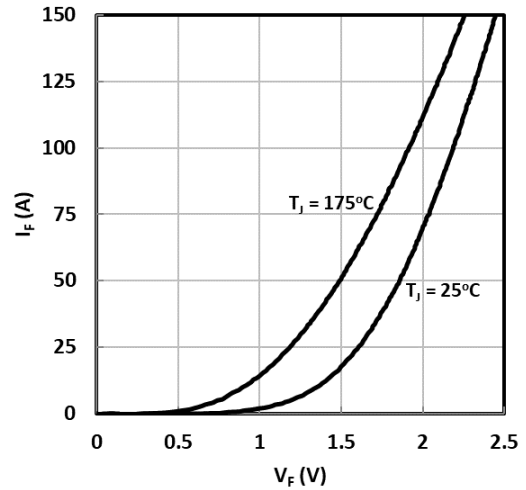

Fig. 10 Typical diode forward current as a function of forward voltage
($V_{GE} = 0V$, $t_p = 250 \mu s$)

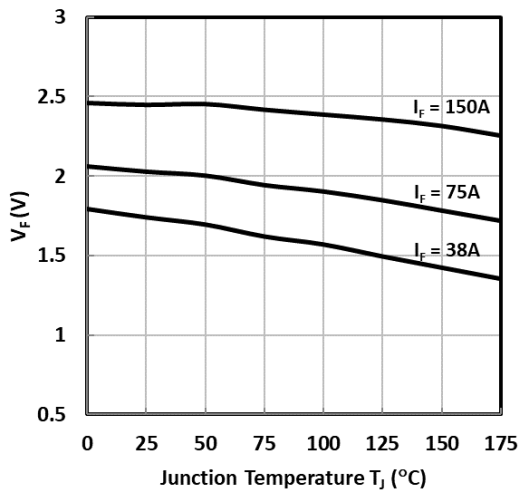
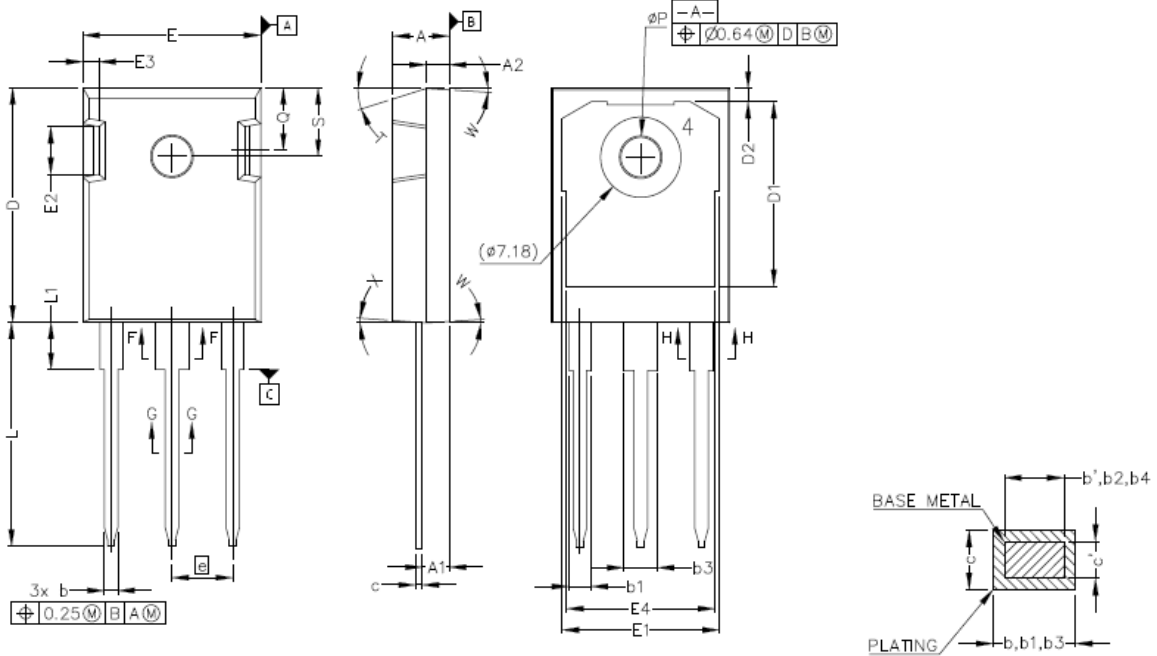

Fig. 11 Typical diode forward voltage as a function of junction temperature
($V_{GE} = 0V$, $t_p = 250 \mu s$)

Package Drawing



SYM	MILLIMETERS		INCHES	
	MIN	MAX	MIN	MAX
A	4.83	5.21	.190	.205
A1	2.29	2.54	.090	.100
A2	1.91	2.16	.075	.085
b'	1.07	1.28	.042	.050
b	1.07	1.33	.042	.052
b1	1.91	2.41	.075	.095
b2	1.91	2.16	.075	.085
b3	2.87	3.38	.113	.133
b4	2.87	3.13	.113	.123
c'	0.55	0.65	.022	.026
c	0.55	0.68	.022	.027
D	20.80	21.10	.819	.831
D1	16.25	17.65	.640	.695
D2	0.95	1.25	.037	.049
E	15.75	16.13	.620	.635
E1	13.10	14.15	.516	.557
E2	3.68	5.10	.145	.201
E3	1.00	1.90	.039	.075
E4	12.38	13.43	.487	.529
e	5.44 BSC		.214 BSC	
N	3		3	
L	19.81	20.32	.780	.800
L1	4.10	4.40	.161	.173
φP	3.51	3.65	.138	.144
Q	5.49	6.00	.216	.236
S	6.04	6.30	.238	.248
T	17.5° REF.			
W	3.5° REF.			
X	4° REF.			

TO-247

Revision history of JHH75N120HA Specification

Version	Change Items	Effective Date
1.00	Initial Release	Jun-21

Notice

General – Information in this document is believed to be accurate and reliable. However, JSAB Technologies does not give any representations or warranties, expressed or implied, as to the accuracy or completeness of such information and shall have no liability for the consequences of use of such information.

Right to make changes – JSAB Technologies reserves the right to make changes to information published in this document, including without limitation specifications and product descriptions, at any time and without notice. This document supersedes and replaces all information supplied prior to the publication hereof.

Suitability for use – JSAB Technologies' products are not designed, authorized or warranted to be suitable for use in medical, military, aircraft, space or life support equipment, nor in applications where failure or malfunction of an JSAB Technologies product can reasonably be expected to result in personal injury, death or severe property or environmental damage. JSAB Technologies accepts no liability for inclusion and/or use of JSAB Technologies' products in such equipment or applications and therefore such inclusion and/or use is at the customer's own risk.

Applications – Applications that are described herein for any of these products are for illustrative purposes only. JSAB Technologies makes no representation or warranty that such applications will be suitable for the specified use without further testing or modification.

Limiting values – Stress above one or more limiting values may cause permanent damage to the device. Limiting values are stress ratings only and operation of the device at these or any other conditions above those given in the Characteristics sections of this document is not implied. Exposure to limiting values for extended periods may affect device reliability.

Terms and conditions of sale – JSAB Technologies' products are sold subject to the general terms and conditions of commercial sale, including those pertaining to warranty, intellectual property rights infringement and limitation of liability, unless explicitly otherwise agreed to in writing by JSAB Technologies. In case of any inconsistency or conflict between information in this document and such terms and conditions, the latter will prevail.

No offer to sell or license – Nothing in this document may be interpreted or construed as an offer to sell products that is open for acceptance or the grant, conveyance or implication of any license under any copyrights, patents or other industrial or intellectual property rights.

Export control – This document as well as the item(s) described herein may be subject to export control regulations. Export might require a prior authorization from national authorities.

Quick reference data – The Quick reference data is an extract of the product data given in the Limiting values and Characteristics sections of this document, and as such is not complete, exhaustive or legally binding.