

FEATURES

- V_{CEsat} with positive temperature coefficient
- Low V_{cesat}
- Low switching losses
- Low inductance case
- Isolated copper baseplate using DBC technology

Preliminary Data

$V_{CES} = 650V$

$I_C \text{ nom} = 400A / I_{CRM} = 800A$

APPLICATION

- Welding Machine
- UPS
- Motor Drives

Equivalent Circuit Schematic

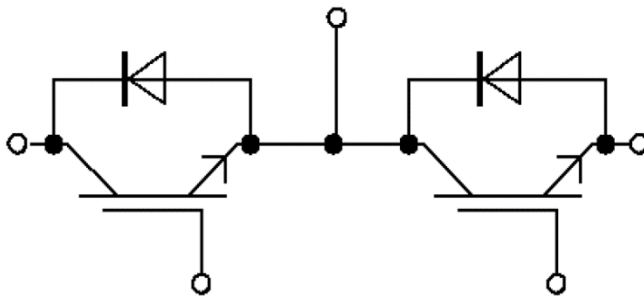

IGBT, Inverter

Maximum Rated Values

Parameter	Conditions	Symbol	Values	Units
Collector-emitter voltage	$T_{vj} = 25^{\circ}\text{C}$	V_{CES}	650	V
Continuous DC collector current	$T_c = 70^{\circ}\text{C}$, $T_{vj} \text{ max} = 175^{\circ}\text{C}$	I_c	400	A
Repetitive peak collector current	$t_p = 1 \text{ ms}$	I_{CRM}	800	A
Total power dissipation	$T_C = 25^{\circ}\text{C}$, $T_{vj} \text{ max} = 175^{\circ}\text{C}$	P_{tot}	1154	W
Gate-emitter peak voltage		V_{CES}	± 20	V

Characteristic Values

Parameter	Conditions	Symbol	Values			Units
			Min.	Typ.	Max.	
Collector-emitter saturation voltage	$I_c = 400\text{A}$, $V_{GE} = 15 \text{ V}$ $T_{vj} = 25^{\circ}\text{C}$	V_{CESat}		1.55		V
Gate threshold voltage	$I_c = 1.5 \text{ mA}$, $V_{CE} = V_{GE}$ $T_{vj} = 25^{\circ}\text{C}$	V_{GEth}		5.8		V
Gate charge	$V_{GE} = -15 / 15 \text{ V}$	Q_G		4.2		μC
Input capacitance	$f = 1 \text{ MHz}$, $T_{vj} = 25^{\circ}\text{C}$, $V_{CE} = 25 \text{ V}$, $V_{GE} = 0 \text{ V}$	C_{ies}		24		nF
Reverse transfer capacitance		C_{res}		0.81		nF
Collector-emitter cut-off current	$V_{CE} = 1200 \text{ V}$, $V_{GE} = 0 \text{ V}$, $T_{vj} = 25^{\circ}\text{C}$	I_{CES}			1.0	mA
Gate-emitter leakage current	$V_{CE} = 0 \text{ V}$, $V_{GE} = 20 \text{ V}$, $T_{vj} = 25^{\circ}\text{C}$	I_{GES}			400	nA
Turn-on delay time, inductive load	$I_c = 400\text{A}$, $V_{CE} = 300 \text{ V}$ $V_{GE} = -15 / 15 \text{ V}$, $R_G = 22\Omega$ $di/dt \text{ (on)} = 1000\text{A}/\mu\text{s}$ $Dv/dt \text{ (off)} = 2900\text{A}/\mu\text{s}$ $T_{vj} = 25^{\circ}\text{C}$	t_{don}		0.58		μs
Rise time, inductive load		t_r		0.35		μs
Turn-off delay time, inductive load		t_{doff}		1.17		μs
Fall time, inductive load		t_f		0.13		μs
Turn-on energy loss per pulse		E_{on}		20.55		mJ
Turn-off energy loss per pulse		E_{off}		26.8		mJ
Thermal resistance, junction to case		per IGBT	R_{thJC}			0.13
Thermal resistance, case to heatsink	per IGBT $\lambda_{Paste} = 1 \text{ W}/(\text{m}\cdot\text{K})$ / $\lambda_{grease} = 1 \text{ W}/(\text{m}\cdot\text{K})$	R_{thCH}		0.03		K/W
Temperature under switching conditions		$T_{vj \text{ op}}$	-40		150	$^{\circ}\text{C}$

Diode, Inverter

Maximum Rated Values

Parameter	Conditions	Symbol	Values	Units
Repetitive peak reverse voltage	$T_{vj} = 25^{\circ}\text{C}$	V_{RRM}	650	V
Continuous DC forward current		I_F	400	A
Repetitive peak forward current	$t_p = 1 \text{ ms}$	I_{FRM}	800	A

Characteristic Values

Parameter	Conditions	Symbol	Values			Units
			Min.	Typ.	Max.	
Forward voltage	$I_F = 400 \text{ A}, V_{GE} = 0 \text{ V}$ $T_{vj} = 25^{\circ}\text{C}$	V_F		1.76		V
Peak reverse recovery current	$I_F = 400 \text{ A},$ $V_R = 300 \text{ V}, V_{GE} = -15 \text{ V}$ $RG = 22\Omega$ $T_{vj} = 25^{\circ}\text{C}$	I_{RR}		107		A
Recovered charge		Q_{RR}		7		μC
Reverse recovery energy		E_{rec}		1.01		mJ
Thermal resistance, junction to case	per diode	R_{thJC}			0.2	K/W
Thermal resistance, case to heatsink	per diode $l_{paste} = 1 \text{ W}/(\text{m}\cdot\text{K}) / l_{grease} = 1 \text{ W}/(\text{m}\cdot\text{K})$	R_{thCH}		0.06		K/W
Temperature under switching conditions		$T_{vj op}$	-40		150	$^{\circ}\text{C}$

Module

Maximum Rated Values

Parameter	Conditions	Symbol	Values	Units
Isolation test voltage	RMS, f = 50 Hz, t = 1 min.	V _{ISOL}	2.5	kV
Internal isolation	basic insulation (class 1, IEC 61140)		Al ₂ O ₃	
Creepage distance	terminal to heatsink terminal to terminal		29	mm
			23	
Clearance	terminal to heatsink terminal to terminal		23	mm
			11	
Comperative tracking index		CTI	>400	

Characteristic Values

Parameter	Conditions	Symbol	Values			Units
			Min.	Typ.	Max.	
Stray inductance module and fixture		L _{sCE}		20		nH
Module lead resistance, terminals - chip	TC = 25°C, per switch	R _{CC'+EE}		0.7		mΩ
Storage temperature		T _{stg}	-40		125	°C
Mounting force per clamp		F	3		6	N
Weight		G		345		g

Output characteristic IGBT, Inverter (typical)

$I_C = f(V_{CE})$
 $V_{GE} = 15V$

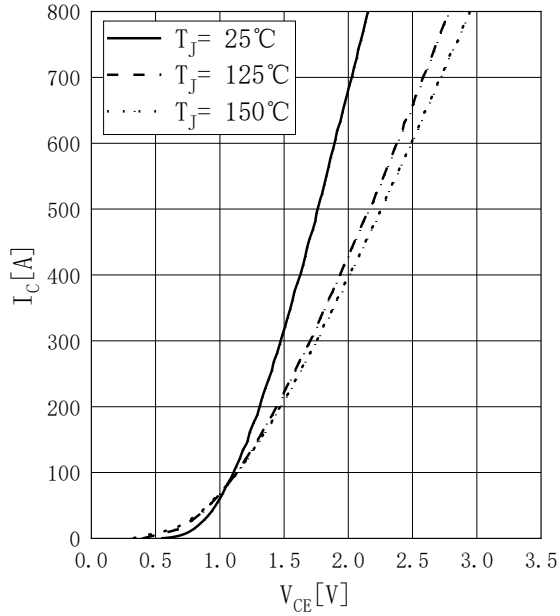

Output characteristic IGBT, Inverter (typical)

$I_C = f(V_{CE})$
 $T_1 = 150^\circ C$

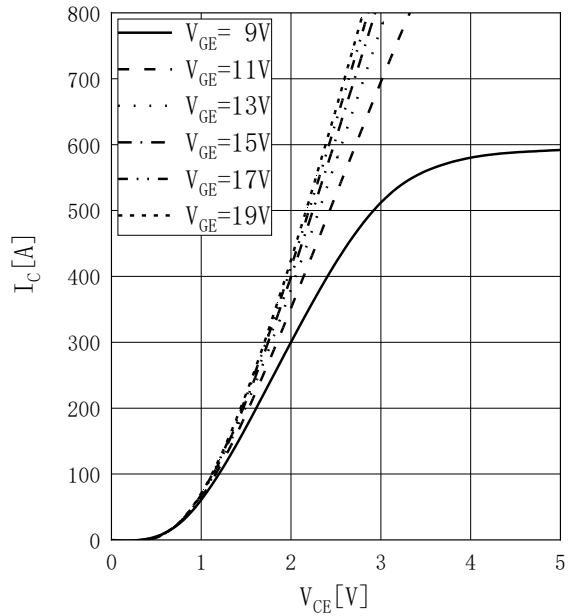

Transfer characteristic IGBT, Inverter (typical)

$I_C = f(V_{GE})$
 $V_{CE} = 20V$

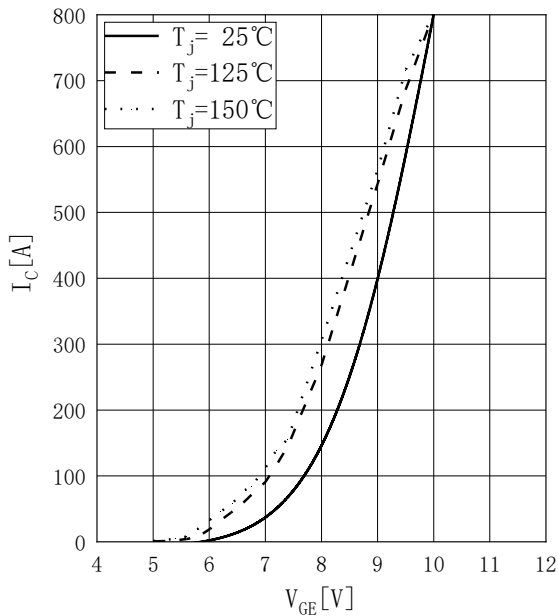

Switching losses IGBT, Inverter (typical)

$E_{on} = f(I_C)$, $E_{off} = f(I_C)$
 $V_{GE} = \pm 15V$, $R_{Gon} = 20\Omega$, $R_{Goff} = 20\Omega$, $V_{CE} = 400V$

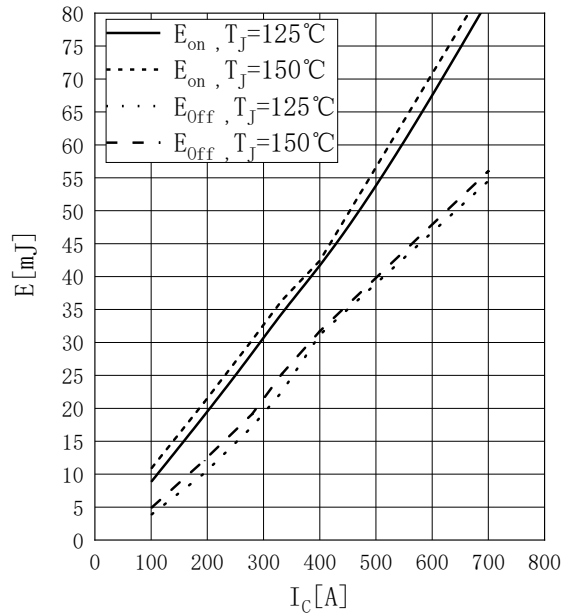

Switching losses IGBT, Inverter(typical)

$E_{on}=f(R_G), E_{off}=f(R_G)$
 $V_{GE}=\pm 15V, I_C=400A, V_{CE}=400V$

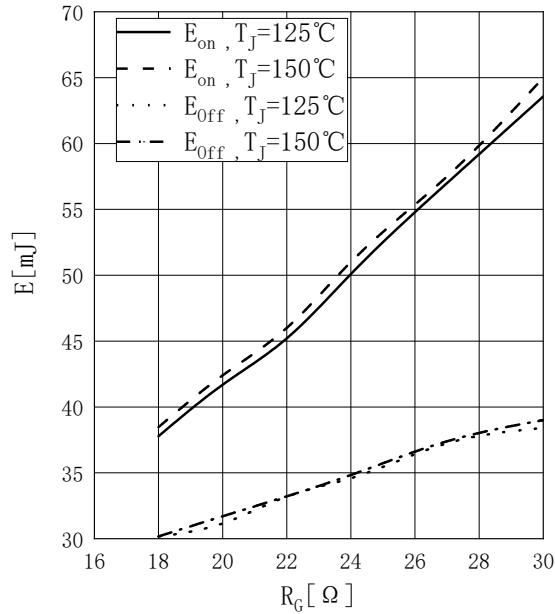

Transient thermal impedance IGBT, Inverter

$Z_{thJC}=f(t)$

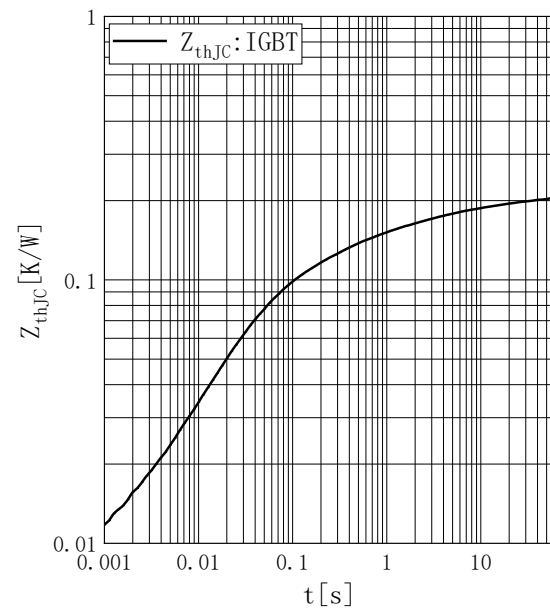

ReversebiassafeoperatingareaIGBT, Inverter (RBSOA)

$I_C=f(V_{CE}),$
 $V_{GE}=\pm 15V, R_{Goff}=20\Omega, T_J=150^\circ C$

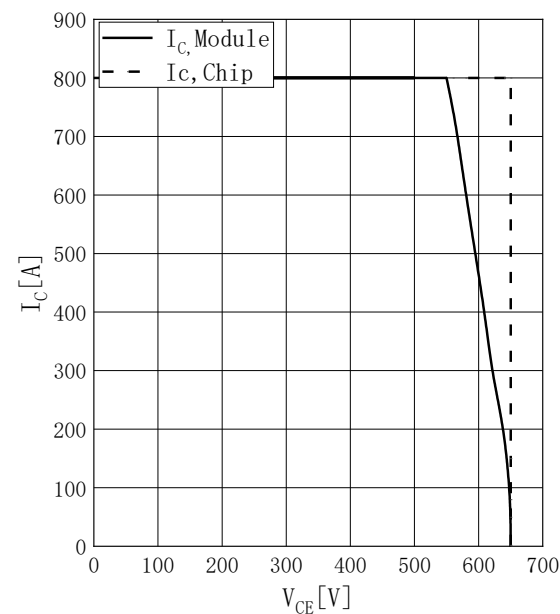

ForwardcharacteristicofDiode, Inverter (typical)

$I_F=f(V_F)$

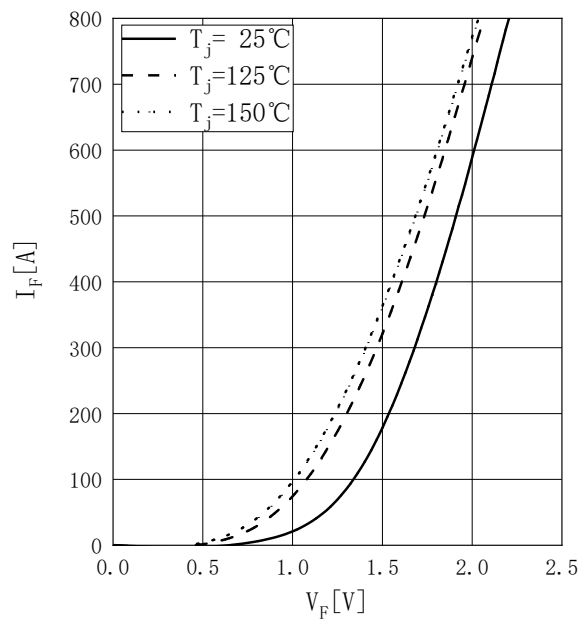

Switching losses Diode, Inverter (typical)

$$E_{rec} = f(I_F)$$

$$R_{Gon} = 20\Omega, V_{CE} = 400V$$

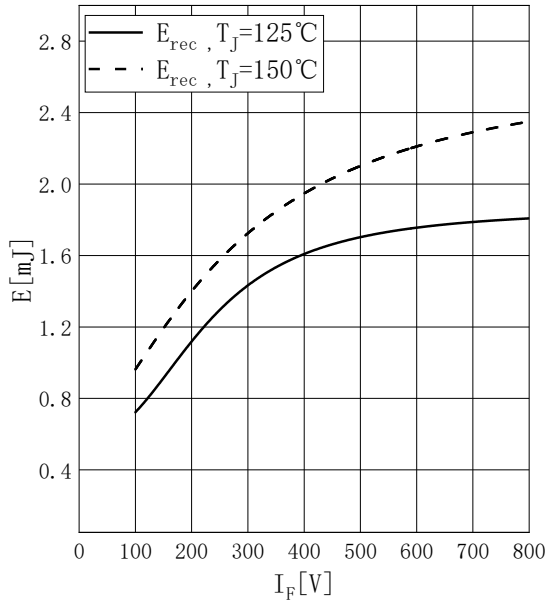

Switching losses Diode, Inverter (typical)

$$E_{rec} = f(R_G)$$

$$I_F = 400A, V_{CE} = 400V$$

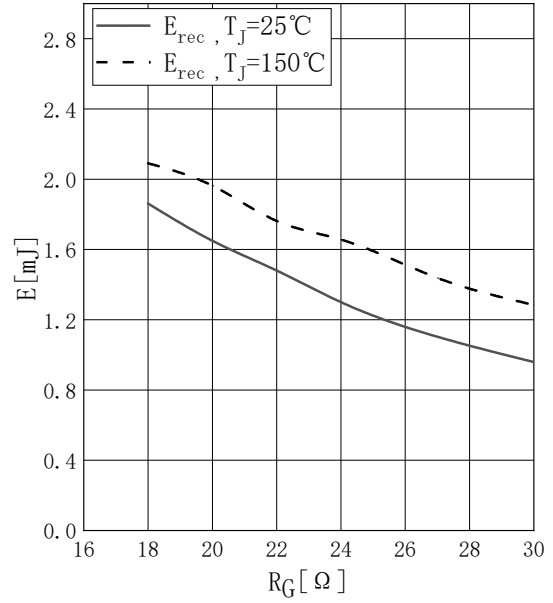

Transient thermal impedance Diode, Inverter

$$Z_{thJC} = f(t)$$

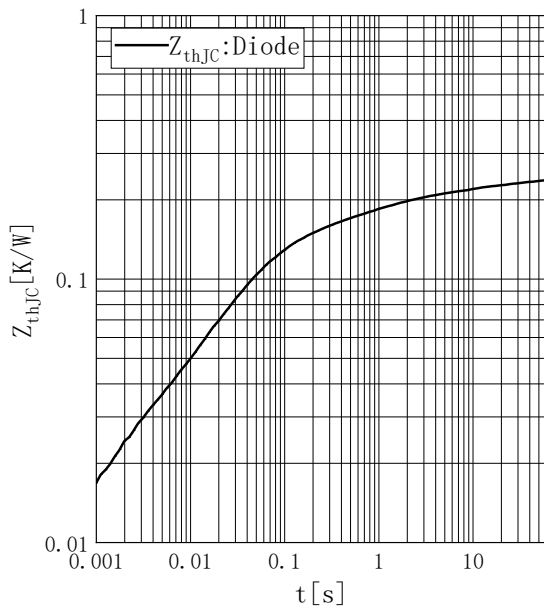

Circuit diagram

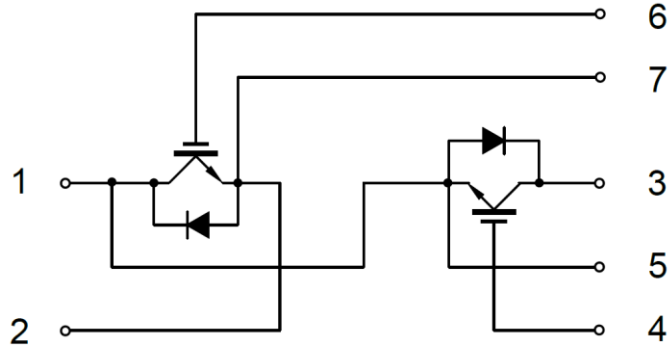

Package outlines (mm)

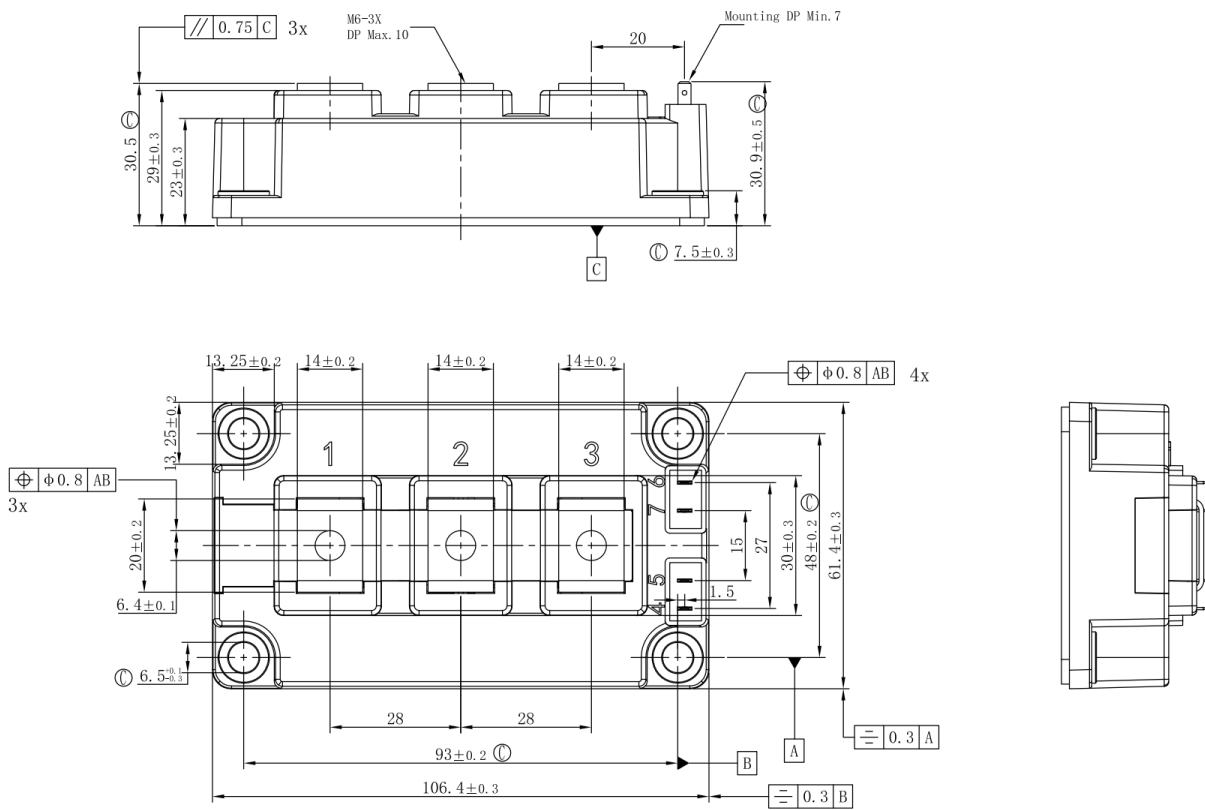

修订时间	版本号	修订内容
2021.10	Preliminary 1.0	初版
2022.05	1.0	正式版, 补充全部曲线